

ECA

European Concept for Accessibility



Technical Assistance Manual

2003

STATEMENT

The fundamental basis of a European philosophy for accessibility is the recognition, acceptance and fostering - at all levels in society - of the rights of all human beings, including people with activity limitations in an ensured context of high human health, safety, comfort and environmental protection. Accessibility is an essential attribute of a "person-centred", sustainable built environment.

EUROPEAN CONCEPT FOR ACCESSIBILITY

May 1985: on demand of the E.C. Bureau for Action in Favour of Disabled People, the Dutch Council of the Disabled carries out a study about the accessibility legislation and practice in the Member States.

October 1987: The Dutch CCPT launches the development of a European Manual with harmonised and standardised accessibility criteria, financed by the European Commission and supervised by a steering group of experts from different European countries.

November 1990: Publication of the European Manual, but it seems to contain too many details for which there is no common European ground.

1996: A new draft with far less pages and details is presented. The title is European Concept for Accessibility. Though it is not a standard, the European Concept for Accessibility is translated into many languages and is used in several countries to renew national approaches and guidelines. The European Commission uses the Concept in the promotion of accessibility.

1999: Transfer of the co-ordination task from the Dutch CCPT to the Luxembourg organisation Info-Handicap. Marketing activity in order to increase the recognition of the European Concept for Accessibility and presentation on the World Wide Web.

2002: Decision to update the ECA

November 2003: Presentation of the updated ECA in Luxembourg.

This publication was produced with the financial support of the
Luxembourg Ministry of Family, Social Solidarity and Youth

IMPRESSUM

Text Francesc ARAGALL
With the support of the EuCAN
Members

Coordination Silvio SAGRAMOLA

Illustrations Francesc ARAGALL
INFOPLA a.s.b.l.
Joëlle MAUS-FREYMANN
Photothèque de la
Ville de Luxembourg

© 2003 EuCAN
c/o Info-Handicap Luxembourg

Internet www.eca.lu

Accessible HTML version <http://homepage.eircom.net/~1idd/>

ISBN 2-919931-24-5

Lay-out CHRIS'

Reproduction is authorized, provided the source is acknowledged.
Visit the website for information about translation procedure.

EuCAN MEMBERS 2003

Andorra	Mr. Fransesc Caballol
Austria	Mr. Wolfgang Enzinger
Belgium	Mr. Vincent Snoeck Mrs. Mieke Broeders Mr. Rodolfo Cattani
Bulgaria	Mrs. Kapka Panayotova
Denmark	Mr. Carsten Graversen
Finland	Mrs. Marttiina Fränti-Pitkäranta Mrs. Maija Könkkölä Mr. Ari Kurppa
France	Mrs. Catherine Cousergue Mr. L. P. Grosbois
Germany	Dr. Peter Neumann
Ireland	Mr. Gerry Kinsella Mr. Cearbhall O'Meadhra Mr. Michal Ozmin Mr. C. J. Walsh Mrs. Fionnuala Rogerson
Italy	Mrs. Mitzi Bollani Mrs. Daniela Orlandi
Great Britain	Mr. Andrew Burke Mr. Ellis Mr. Ken Ewart Mrs. Lisa Foster Mr. S. Goldsmith Mrs. Sarah Langton-Lockton Mr. C. Wycliffe Noble Mr. Alan Richards
Greece	Mrs. Argyro Leventi Dr. eng. Nikos Sakkas
Hungary	Dr. techn. Tibor Polinszky Mr. Sandor Radai

Luxembourg Mr. Gilbert Huyberechts
Mr. Silvio Sagramola

Netherlands The Mr. Theo Bougie
Mr. Maarten van Ditmarsch
Mr. Louis Stegmeijer
Mr. Bas Treffers
Mrs. Els de Vries
Mr. Maarten Wijk

Norway Mrs. Edel Kristin Heggem
Mr. Tone Ronnevig
Mr. Finn Aslaksen

Poland Mrs. Maria Goreczna

Portugal Mr. A. Charana
Mr. Peter Colwell
Mr. Carlos Pereira

Romania Mr. Daniel Chindea

Spain Mr. Francesc Aragall i Clavé
Mr. Nicoleu Juan Pujal
Mr. Juan Antonio Romero Mejias
Mrs. Cristiana Rodriguez-Porrero Miret
Mrs. Imma Bonet

Sweden Mr. Finn Petrén
Mrs. Elisabet Svensson
Mrs. Elena Siré

Switzerland Mr. Joe A. Manser

ACKNOWLEDGEMENTS

This “European Concept for Accessibility - ECA 2003” is the result of exemplary cooperation between a number of partners who share a strong commitment to the improvement of accessibility in the built environment as an essential condition for guaranteeing equal opportunities and full participation for ALL European citizens.

The publication by the Dutch CCPT of the “European Manual for Accessibility - 1990” and the “European Concept for Accessibility - 1996”, thanks to the enthusiasm of my predecessor, Maarten Wijk, were important milestones in the discussion on accessibility in Europe.

Members of the European Concept for Accessibility Network (EuCAN) have contributed their knowledge and competences on a voluntary basis for many years to the preparation of this document, thus underpinning its European dimension. As coordinator, I should like to take this opportunity to express to them all my admiration and gratitude for their devotion.

The outstanding feature of this updated “European Concept for Accessibility - ECA 2003” is the fact that the numerous contributions of the experts have been incorporated into a coherent text which clearly illustrates the multiple facets of accessibility.

Many specific articles, completing or illustrating different chapters of the document, were submitted by experts. More texts have been promised for the electronic version. In this connection, I am delighted to pay tribute to the invaluable work of Cearbhall O’Meadhra for the on-line presentation of the document in an accessible format for blind persons.

The warm welcome we have always been given by the various European Institutions, and our excellent relations with NGOs - particularly the “European Disability Forum” - and European networks have been and will remain an important motivating factor for our work.

Accessibility is becoming a natural component of European communications, recommendations and directives. We should like to congratulate the political decision-makers for their perspicacity in considering accessibility to be an essential quality criterion.

I should like to thank the Luxembourg Ministry of Family, Social Solidarity and Youth for its support, without which coordination of the EuCAN and the publication of this document would not have been possible.

Finally, special thanks are due to Francesc Aragall and C.J. Walsh for their commitment and enthusiasm throughout the preparation of the “European Concept for Accessibility - ECA 2003”.

Silvio Sagramola
EuCAN coordinator

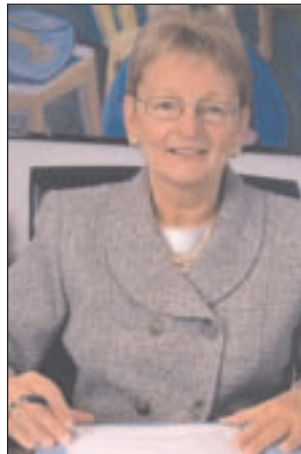

FOREWORD

This publication « European Concept for Accessibility » (ECA) is an excellent example of uniting experts from 22 European countries in a common cause for establishing a harmonized European approach to accessibility.

The updated ECA is now the result of many years of efforts to build a European society for everyone.

When, in 1999, the coordination task of the ECA network passed from the Dutch CCPT to the Luxembourg organisation INFO-HANDICAP, our country had not yet finalized the accessibility legislation. In 2001 our country could pass the law on accessibility but still many efforts have to be done to establish a real culture of accessibility.

The collaboration with the ECA network has been extremely constructive and contributed to reinforce Luxembourg's, as well as other countries' efforts to reach a more equal society, accessible by all citizens at all levels. Experts throughout Europe exchanged their views on a "design for all" approach for a fully inclusive society. We are indeed very grateful for all initiatives in this direction and for the know-how from well-known experts in accessibility. Changing attitudes needs time as well as the implementation of the laws. Therefore we are thankful for the collaboration within the European nations.

I also would like to express my appreciation towards INFO-HANDICAP for their commitment in coordinating this gigantic work and congratulate the entire ECA network for their achievement.

Marie-Josée Jacobs

Minister of Family, Social Solidarity and Youth

FOREWORD FOR EUROPEAN CONCEPT OF ACCESSIBILITY PUBLICATION

As President of the European Parliament Disability Intergroup I welcome this publication of the revised European Concept of Accessibility.

The ECA has proved to be a useful means to raise awareness among architects, planners, designers and constructors of what the principles of design for all and universal access mean. The concept of universal design, enshrined in the ECA is the cornerstone of a fully inclusive society.

The ECA network has also proved to be an important force in the campaign for mandatory European standards on accessibility. As a network of experts, architects and designers working in the field of design for all, calling for a commonly recognised definition of design for all and for a European standard on accessibility to be taken up by all EU member states it has supported the calls of the European disability movement.

The Disability Intergroup a cross party, cross national grouping of MEPs has been campaigning for a long time for an EU legislative initiative in the field of access to the built environment and access to goods and services. Accessibility for all is a fundamental right, and any environmental barrier which denies access and free movement for disabled persons or other persons with reduced mobility is and must be recognised as discrimination.

As a result of continuous pressure by the Disability Intergroup, during this European Year of Persons with Disabilities 2003 there is an accessibility audit currently underway of the EU institution - notably the European Parliament, the European Court of Justice, the Committee of the Regions and the Economic and Social Committee. This audit is to examine, in a holistic way, the shortfalls in the design of the buildings, facilities, information systems and recruitment practices of the EU institutions in relation to access to people with disabilities. At the same time the recommendations arising from this audit should lead to the benefit of all persons using the EU institutions, not just persons with disabilities.

As a result of the different calls for action being made by the disability movement, the Disability Intergroup and the ECA network, the European Commission have sponsored the creation of an independent Expert Group on Access to the Built Environment to examine what needs to be done in this field at EU level and to present a series of recommendations to the EU. The European Concept of Accessibility will benefit the work of this group; it provides a useful instrument to develop a common European standard on accessibility.

The revised ECA will make a valuable contribution to the move toward a design for all approach across Europe. We all have a responsibility to exert the pressure necessary on all decision makers and key actors to get the ECA put into practice.

Richard Howitt MEP

President the Disability Intergroup of the European Parliament June 2003

THE IMPORTANCE OF THE EUROPEAN CONCEPT OF ACCESSIBILITY IN THE BREAKING DOWN ENVIRONMENTAL BARRIERS

by the Chair of the European Disability Forum Committee on Universal Access

The European Disability Forum, the umbrella organisation of the European disability movement, works in cooperation with the European Concept of Accessibility Network. EDF welcomes the work done by EUCAN in developing this publication, the technical assistance manual on the European Concept of Accessibility. This publication is an important awareness raising and training tool for professionals in the field of the designing, planning and construction of the built environment and also for disability organisations and disabled people themselves.

EDF has said many times that the issue of accessibility has to be regarded as a rights based issue for disabled people and society at large. We are fighting to eliminate the segregation of disabled people from society. We, as disabled people, must be able to move freely around within our own countries but also across Europe and be able to access and use goods and services without difficulty as non-disabled people do.

Breaking down barriers in the built environment is one area which has not been adequately addressed at either the European or the national level, either due to lack of adequate legislation or lack of implementation and enforcement of legislation. It is an area where disabled people are experiencing daily frustrations and obstacles which hinder our daily lives.

Accessibility must be considered a horizontal issue and there has to be clear and binding European Community standards on accessibility which oblige the construction industry and related stakeholders to fully take on board the principles of accessible design.

EDF has, since early 2003, been campaigning for an EU Disability Specific Directive which would include legal provisions on access to the built environment. Without equal access to the built environment disabled people can never achieve free movement and equality with non-disabled persons. But there must be complementary measures in addition to legislative initiatives in this field.

For example, there is an important lack of awareness among relevant actors of the moral and legal obligations to build barrier free environments and the benefits of securing a barrier free built environment for not only disabled persons but all persons in society. This lack of awareness is particularly noticeable within the design, planning and construction industry itself.

Both EUCAN and EDF have important work to do in training the relevant stakeholders and promoting regular dialogue and information exchange between so called built

environment experts and organisations OF disabled people, where disabled people themselves are able to explain the obstacles they face to their mobility.

The European Commission funded EU expert group on Accessibility produced its final recommendations in a report presented in October 2003. EDF was represented on this expert group by our Vice-President, Bas Treffers.

EDF welcomes the recommendations presented by this report and will campaign vigorously for follow-up and implementation of the EU experts proposals. Proposals which include the call to amend existing EU legislation to insert accessibility for all criteria such as in field of construction products and health and safety and to include the issue of accessibility in public procurement tenders.

EDF has been successful in its campaign for there to be explicit reference in the revised EU Directives on Public Procurement to include where justified "design for all requirements (including the accessibility for disabled people)" in the technical specifications of products and services to be tendered - to include technical instruments like telephones, computers and office and meeting room facilities and also access to buildings.

EDF also supports the recommendations of the expert group to require on a mandatory basis audits of existing constructions every 5 years and the call for explicit accessibility requirements among the criteria for allocation of EU funding from programmes on reconstruction and development, such as the EU Structural Funds (the European Regional Development Fund) and the Cohesion Funds.

EDF will continue to work in close cooperation with the EUCAN network to promote shared aims and objectives on accessibility for all in the built environment and more widely in the field of access to goods and services.

This EUCAN publication of the European Concept of Accessibility will serve an important purpose in assisting this campaign and bringing about concrete change.

2010 A Europe Accessible for All: Report of the Group of Experts set up by the European Commission, October 2003
http://europa.eu.int/comm/employment_social/index/final_report_ega_en.pdf

SUMMARY

CHAPTER 1	OBJECTIVES AND DEFINITIONS	013
	INTRODUCTION	014
	TO WHOM THE ECA IS ADDRESSED?	014
	WHY EUROPEAN?	017
	WHY A CONCEPT?	018
	WHY A BUILT ENVIRONMENT?	018
	WHY ACCESSIBILITY?	020
	CITIES EVOLUTION AS EXAMPLE OF ACCESSIBILITY IMPROVEMENT	022
CHAPTER 2	PEOPLE-CENTRED APPROACH	027
	HUMAN DIVERSITY	028
	Changes during the life cycle	028
	Dimensional, perceptual, motor and cognitive diversity	031
	Demographic diversity	036
	The richness of diversity	037
	Future trends and lifestyles	039
	OPPORTUNITIES	041
	Opportunities for users	041
	Opportunities for designers	042
	Opportunities for property developers	044
	Opportunities for business	045
	Opportunities for politicians	048
CHAPTER 3	RECOMMENDATIONS FOR ACCESSIBLE ENVIRONMENTS	051
	INTRODUCTION	052
	OPEN SPACES	052
	Thoroughfare	052
	Street maintenance	057
	Recreational areas	058
	PUBLIC TRANSPORT	062
	PRIVATE TRANSPORT	068
	PUBLIC BUILDINGS	069
	HOUSING	077
	PUBLIC INFORMATION SERVICES	080
CHAPTER 4	RECOMMENDATIONS FOR MANAGING THE ACCESSIBILITY: THE EXAMPLE OF MUNICIPALITIES	083
	THE CITY FOR ALL PLAN	084
	1. Diagnosis	084
	2. Political planning	085
	3. Involvement of citizens	087
	4. Technical planning	087
	5. Contribution of citizens	090
	6. Management	090
	7. Information to citizens	092
CHAPTER 5	WIDENING EUROPE WITHOUT REPEATING MISTAKES	095
ANNEX	ACCESSIBILITY STANDARDS	099

CHAPTER 1

OBJECTIVES AND DEFINITIONS

INTRODUCTION

The European Concept for Accessibility 1996 was the result of a request from the European Commission, made in 1987. The Concept was based on the universal design principles. These principles apply to the design of buildings, infrastructure, building and consumer products.

1. The objective is the provision of environments which are convenient, safe and enjoyable to use by everyone, including people with disabilities.
2. The universal design principles reject the division of the human population into able-bodied and disabled people.
3. Universal design includes supplementary provisions where appropriate.

This statement was supported by all members of the steering group present in Doorn, The Netherlands, 2 March 1996.

In this 2003 edition we furthermore develop the social reasons to create environments for all and the improvement that Europe can achieve by doing this.

The mainstream use of Internet allows us to constantly enlarge and update the contents through our website: www.eca.lu.

TO WHOM THE EUROPEAN CONCEPT FOR ACCESSIBILITY IS ADDRESSED?

The design of the spaces in the built environment is not the responsibility of the architects alone. Most of us as politicians, professionals, citizens or entrepreneurs influence the design of our environment. Therefore this publication is addressed to two groups of people.

On the one hand, to all those who are willing to contribute to define the characteristics of our environment bearing in mind the human diversity and the difficulties that these spaces can create to the majority of the population.

On the other hand, to all those professionals and politicians who are already aware that the built environment should be accessible for all and are willing to contribute to the European effort of harmonisation in this field.

The close relation between this book and the ECA website will also allow to all the experts in the field to continuously contribute and thus increase the knowledge on this subject.

The European Concept for Accessibility (ECA) is NOT a European policy document but it can be a source of inspiration for political action. It is NOT a technical manual, but it can be a source of information for the development of regulations and standards.

The European Concept for Accessibility should serve as a bridge linking the different areas where specialists for specific topics do their work. It aims at making everybody aware of the work done by others and to encourage all these people who put their expertise together in order to come to a concerted result, which should then be ACCESSIBILITY FOR ALL.

LOBBYING FOR ACCESSIBILITY

At European level, I have followed the discussions about accessibility since the early nineties: many enthusiastic and passionate things have been said and written. The fact remains that we still cannot claim that Europe is accessible for all.

Why has the outcome been so meagre, despite so many political statements and commitments in favour of accessibility?

Could it be that greater efforts have to be made in order to approach and to persuade each single group of people who have a role to play in putting accessibility into practice?

Some positive examples seem to confirm this way of thinking:

- The European Lifts directive is the result of close negotiations between representatives of the disability movement and the lifts industry.
- The European Buses and Coaches directive was partly the result of intensive lobbying by the European Disability Forum and its member organisations.
- Those cities in Europe with the best accessibility have a clearly defined strategy for consultation with all protagonists who can help to establish so-called accessibility plans.
- At local level the best results in adopting a Design for All approach are achieved by particular partnerships having common goals (commitment label).
- The idea of partnerships is also a basic element in the philosophy of European projects and many good ideas have been born during European projects.

The conclusion would seem to be that there is a definite link between the personal commitment made and the chances for success of initiatives aimed at improving accessibility.

Many different interests and strategies are used to deal with accessibility and I am inclined to believe that this variety is the reason why things do not evolve in a coherent fashion.

I believe that there should be a "European Agency" responsible for monitoring discussions on accessibility, gathering European official texts and sending them to anybody who asks for them, and collecting examples of good practice which can be used as coaching tool and transferred to other situations.

This "European Agency" would be the focal point for organising conferences, meetings, training sessions and the development of tools for information, training and awareness-raising - at European level - enabling knowledge to be shared. For example, this agency should translate interesting tools and documents in all the official European languages in order to make them ... accessible to everybody.

Of course work at local level should be done by local players, with their own local structures, but they could at least make use of existing knowledge in the language they need in their own context.

In such a system there would be no excuse for lack of progress. Europe has to provide the professional framework, but the motivation and interest to improve accessibility must still come from the base, that is from users, technicians and politicians.

Silvio Sagramola (visit www.eca.lu to find out more)

WHY EUROPEAN?

If it is true, that everybody has the same rights and duties with respect to education, employment, health and quality of life, then it is essential that they also have equal opportunities in terms of accessing them, as it is defined in the United Nations Universal Declaration of Human Rights Declaration from 1948.

The aim of the ECA, therefore, is to improve and extend the European consensus on the characteristics which the built environment (buildings, streets, etc.) should have, such that all Europeans, irrespective of cultural differences, may enjoy a life that is independent and free of obstacles, wherever they are in the continent.



Picture 001 > Everybody should be able to freely circulate in our continent

On 14/03/2001, DG Employment and Social Affairs and Eurostat jointly issued the second annual Report on the Social Situation in Europe. The Report provides quantitative and qualitative analysis of European social trends with particular focus on the quality of European citizens' lives. Following the Lisbon Summit and the approval of the Social Policy Agenda at the Nice European Council, the concept of quality is more than ever at the heart of the Community agenda.

http://europa.eu.int/comm/employment_social/news/2001/mar/73_en.html

© European Communities, 1995-2002

Reproduction is authorised, provided the source is acknowledged, save where otherwise stated.

Where prior permission must be obtained for the reproduction or use of textual and multimedia information (sound, images, software, etc.), such permission shall cancel the above-mentioned general permission and shall clearly indicate any restrictions on use.

WHY A CONCEPT?

We form concepts so as to order and give shape to our thoughts, analysing the information we receive and comparing it with what we already know in the search for a coherent statement that will lead us towards real knowledge.

The European Concept for Accessibility is the tool we should use to order and give shape to our environment, so that it becomes suitable for each and every one of its users. In order to do so, we have to analyse existing information and compare it with the real needs of the population, always remembering that the common feature of this population is precisely its diversity.

Thus, the European Concept for Accessibility (ECA) has to be a basic guideline to everyday working to all those people and bodies who are involved in building our environment - like politicians, construction firms, designers, employers.

As it has already been pointed out, this does not imply standardisation or cultural uniformity. Working with this concept means respecting the functional requirements of accessibility, maintaining the distinguishing characteristics of each culture and the customs of different population groups.

Therefore, the ECA is not a series of tables of measures and materials, but rather a guide to the features which imply quality of life.

In summary: Environments created under the European Concept for Accessibility have to respect a country's identity and the customs of its people, but they also have to respond to social and technological progress. In other words, they have to take into account the diversity of the population and progressive advances in quality standards.

WHY A BUILT ENVIRONMENT?

Two types of environment can be distinguished: natural and built.

1. **Natural environments:** their development depends solely on the action of natural elements (rain, wind). As soon as natural environments like for example forests are modified in order to be used by people, they become part of the built environment.

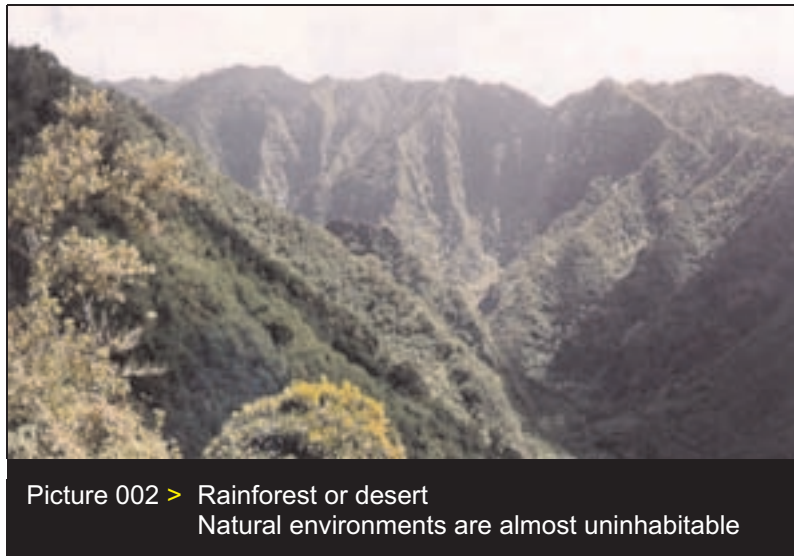

2. **Built environments:** these are environments created or modified by people so that people may live in them.



Examples of built environments: buildings, squares, vehicles (transport), parking spaces, streets, children's play areas, monuments, water/gas installations, etc. natural parks - in which plant life is protected, and designated paths and different services are provided and beaches - with equipment (ramps, walkways on the sand, etc.) that facilitates access to them and the various services they offer, and which provides specific assistance in terms of bathing (floats for children, floating chairs for people with mobility problems, or buoys to indicate safe areas).

Thus, the built environment refers to any space or facility designed by people for people, whether public or private, and its accessibility therefore depends on us.

However, this publication refers especially to architecture and town planning, as it takes longer to bring about change once a building project is completed: if designs are made without taking into account accessibility, then buildings and space may remain inaccessible for a long period of time, and correcting them at a later stage can be costly.

WHY ACCESSIBILITY?

Built environments should enable all individuals to develop as persons. Thus, their design has to take into account the diversity of the population and the need which we all have to be independent. Therefore, built environments, including each of their elements and components, should be designed in a way that they enable everybody to access the different opportunities available: i.e. culture, space, buildings, communications, services, economy, participation, etc.

Thus, an accessible environment has to be:

1. **Respectful:** it should respect the diversity of users. Nobody should feel marginalized and everybody should be able to get to it.
2. **Safe:** it should be free of risks to all users. Therefore, all those elements which form part of an environment have to be designed with safety in mind (slippery floors, parts jutting out, dimensions, etc.).
3. **Healthy:** it should not constitute a health risk or cause problems to those who suffer from certain illnesses or allergies. Even more, it should promote the healthy use of spaces and products.
4. **Functional:** it should be designed in such a way that it can carry out the function for which it was intended without any problems or difficulties.

For example, it would be absurd to design a medical centre without bearing in mind that the width of the corridors should allow two stretchers to pass each other and that the doors have to be wide enough for a stretcher to pass through them.

5. **Comprehensible:** all users should be able to orient themselves without difficulty within a given space, and therefore the following is essential:
 - a. **Clear information:** use of icons that are common to different countries, avoiding the use of words or abbreviations from the local language which may lead to confusion; for example, using the letter C on taps, which suggests Cold in English but Caliente (meaning hot - exactly the opposite) in Spanish.
 - b. **Spatial distribution:** this should be coherent and functional, avoiding disorientation and confusion.

6. **Aesthetic:** the result should be aesthetically pleasing, as this will make it more likely to be accepted by everybody (the previous five points always being borne in mind).

EXTRACT OF THE REPORT FROM THE GROUP OF EXPERTS SET UP BY THE E.C.

An accessible built environment is a key element for the realisation of a society based on equal rights, and provides its citizens with autonomy and the means to pursue an active social and economic life. It is a cornerstone of an inclusive society, based on non-discrimination. Our society is based on diversity, which entails a need to build a barrier-free environment, that does not *create* disabilities and impairments. It means that accessibility is a concern for everyone, not only for a minority with special needs. With an increasingly diverse and ageing society, the objective should - and will - increasingly be to promote accessibility for all.

Accessibility is thus an intrinsic part of the strategy launched at the Lisbon Summit, in March 2000, that aims to foster growth, employment and social cohesion. Because accessibility benefits everybody, it strengthens inclusion and promotes an active participation of people with disabilities in economic and social life.

This strategy has a target date: 2010. This is why the "accessibility agenda" which is fleshed out in this report should be implemented with this same 2010 deadline. By this date, all new constructions, their vicinity (pavement, bus stops,...) and their environment (signage, electronic devices,...), should be accessible for all. Such an effort will require a strong political commitment - to be reinforced at the next Spring European Council 2004. This commitment is necessary to trigger all the concrete steps, across a broad range of policies - from transport to information technologies, from spatial planning to construction - and by all concerned actors, that will be needed to deliver real progress.

2010: A EUROPE ACCESSIBLE FOR ALL - Report from the Group of Experts set up by the European Commission (visit www.eca.lu to read more about this)

CITIES EVOLUTION AS EXAMPLE OF ACCESSIBILITY IMPROVEMENT

The primary need of first population settlements was protection against threats from outside. Since then, cities have evolved to respond to the needs which have arisen during the course of history.



Picture 004 > A walled area
The protection against the external aggressions was one of the first cities' priorities.

© copyright Photothèque de la Ville de Luxembourg
F. Buny

Thus, the development of towns and cities is led by social demand, i.e., the needs of the population at different points in history. However, the way in which towns and cities develop also has a direct effect on social awareness. An environment which excludes a certain group leads the population as a whole to exclude that group from their day-to-day activities. As a result, the group marginalizes itself, ghettos and specific group spaces being the consequence.



Picture 005 > Avenue de la Gare: full of cars

© copyright Photothèque de la Ville de Luxembourg
J.P. Fiedler



Picture 006 > Avenue de la Gare: in the last years pedestrians have won space from cars

© copyright Photothèque de la Ville de Luxembourg
C. Hommel

Therefore, bearing in mind that the development of towns and cities depends upon social demand (work, education, leisure, trade, economy, etc.), and that social demand is currently moving toward equal opportunities for everybody, regardless of whether they live in or outside the city, then it becomes essential that all built environments include those characteristics necessary to provide such equality, that is to say, they have to be accessible.

To sum up, accessibility is the characteristic of an environment or object which enables everybody to enter into a relationship with, and make use of, that object or environment in a friendly, respectful and safe way. This means equal opportunities for all users, regardless of their capabilities, cultural background or place of residence, in all those activities which form part of their social and individual development. Therefore, accessibility promotes equal opportunities, not the uniformity of the population (in terms of culture, customs or habits).

As an evolution of this approach, the concept of Design for All is used nowadays. This is understood as the intervention in environments, products and services so that everybody is able to participate in the creation of our society, providing him/her with equal opportunities to take part in economic, social, cultural and leisure activities. Furthermore, enabling all users to access, use and understand the various parts of the environment independently, irrespective of their age, gender, abilities or cultural background.

In addition, Design for All ensures that future generations enjoy, to the same extent, a favourable environment that is built with everybody in mind (sustainability). Thus, Design for All can be said to be a philosophy and planning strategy whose aim is universal access.

CITIES EVOLUTION AS AN EXAMPLE OF ACCESSIBILITY IMPROVEMENT

Finally, as a way of illustrating the above, it would seem of interest to briefly review the development of towns and cities, as this development has always been linked to both changes in social needs - such as safety, health and respect - and, therefore, to adaptations of the environment so that it meets people's needs.

The first population groups settled in areas that were rich in terms of production (fishing, farming) and this marked the end of nomadic life. Although what was produced on a given piece of land was initially aimed at feeding the family who worked it, people later started to store any surplus and then sell it, thus giving rise to what we now know as trade.

The birth of trade also saw the emergence of private property and, consequently, the need to protect it. This in turn brought with it the inaccessibility of towns and cities, either because of walls being built around them or because they were developed in a place that was inaccessible due to its natural characteristics (for example, mountain peaks, closed valleys). As people settled permanently in a given place the need to develop hygiene systems (cleaning of public spaces, sewers) in order to assure a minimum quality of life also became apparent.

Towns and cities as we know them today came about for three reasons:

1. The increase in population brought with it the need to make towns and cities bigger and this led to the destruction of surrounding walls.
2. The need for mobility and transportation of goods within the town or city led to the development of street plans and the appearance of pavements (differentiating the area meant for people from that meant for carts).
3. Spurred on by trade beyond city borders, towns sprung up along the coasts and roadsides, places which were more accessible.

Later, the development of towns and cities was linked to the modernisation of industry, trade and transport, giving rise to urban building that reflected these advances: housing schemes, dormitory towns, housing and industrial estates, etc. Finally, towards the end of the twentieth century, the modernity of a town or city became defined by the number of cars, the amount of services (irrespective of their quality) and the possibility of consumption.

However, for the last decades, people have begun to demand civil rights, equal opportunities: towns and cities for all which belong to us all.

In the face of such a specific social demand - equal opportunities for all, irrespective of our ability, cultural background or where we live - it is essential that the diversity of the population is taken into account when environments are developed, for failure to do so will only favour a certain group.

Thus, the development of towns and cities is led by social demand, that is, the needs of the population at different points in history. However, the way in which towns and cities develop also has a direct effect on social awareness, in that an environment which excludes a certain group leads the population as a whole to exclude that group from their day-to-day activities and, therefore, the group marginalizes itself, ghettos and specific group spaces being the result.

Imma Bonet (visit www.eca.lu to read more about this)

CHAPTER 2

PEOPLE-CENTRED APPROACH

HUMAN DIVERSITY

It is unfortunate that even today many people still believe that decisions regarding an individual's welfare and his/her integration into society can be based upon personal differences (race, gender, beliefs, age, abilities, circumstances, etc.).

For to deny that human diversity enriches culture and, consequently, each individual who develops within it, is to deny the innate ability which all of us have to learn and benefit from new situations.

To accept diversity, however, is to accept ourselves for who we are in all our facets, both those which are regarded as positive by society (for example, bravery, altruism, kindness, ingenuity) and also those which are less socially acceptable (fears, needs, different ideas, etc.).

Changes during the life cycle

Individual difference starts with the genes combination. That brings the human diversity which is not only a reality at a social level (we are all different), but also at an individual one: other people are different from me and I myself am not the same person throughout the successive stages of my life.

However long or short, interesting or monotonous, stimulating or unexciting, rich or lacking in personal relationships someone's life might be, there are always dimensional, biological and cognitive changes which themselves produce change when we relate with our bodies and interact with our environment.



Changes during the life cycle are inevitable. Some changes may be brought forward or postponed as a result of an individual's attitude to life, for example, with respect to food, sport, or the balance achieved between work, leisure activities and rest. However, it is also the case that accidents, illnesses or those personal choices also affect our way of relating to the environment without giving us the opportunity to avoid them or choose the best moment.

Although nobody denies that babies are totally dependent upon adults - all cultures acknowledge this - we readily assume that the baby will soon grow and become independent. This is why when we create our environment we so easily forget these small users.

However, problems of relating to our environment do not only affect us during the first years of life, but whenever we find ourselves in a situation which, to a greater or lesser degree, makes such interaction difficult (pregnancy, illness, lack of time, old age, ...).

When we are babies we live in an environment that is not designed with us in mind, and it is the adults who look after us who have to alter it, as best they can, so as to protect us from potentially dangerous situations.

The problem with these "domestic fixes" is that being a parent is not synonymous with being a safety expert, and we often realise the potential danger of a design when it is already too late, that is, when an accident has already happened.

- Moving from the stage of baby to that of child implies the acquisition of a certain independence from adults. The degree of personal autonomy will largely depend on whether the facilities available in the environment enable such development. (biscuit packets or juice cartons which are easy to open, tables and chairs that can be adjusted to different heights, etc.).
- Having got through childhood we have developed a good knowledge of the social reality and environment in which we live; the different elements of this environment more or less adapt to the dimensions of our bodies; we have learnt to read, write, talk, listen, and interpret the various informative signs around us.
- However, reaching adolescence brings with it other kinds of interaction problems: relationship problems between parents and children; visits to countries whose language and culture are different from our own; the need to develop our cultural knowledge (museums, shows, etc.); or the need to have social contacts and the need to find opportunities to express our social, political and personal ideas.
- When we reach adulthood we have a job that we like and which motivates us, an income that enables us to do what we want, a home that meets our needs, a friendly environment that respects us and which motivates us to be respectful, and a satisfactory cultural level. If we have all these things, and provided we don't have any learning, physical or sensory disability, then we won't have any problems in interacting with our environment until the first signs of biological ageing (loss of sight, hearing, memory or motor ability, changing physical aspect, etc.) appear.

These four points trace the life of a person (from birth to old age) who is isolated from reality, that is to say, in whose development only two variables have played a part: the ability to learn and physical and biological development.

However, it should be remembered that everyday life confronts us with a series of circumstances which can make it difficult for us to relate to our environment. These difficulties may result from changes in the environment, changes in the individual or changes chosen by people themselves and which have repercussions for their lifestyle:

- a. Changes in the environment: wet or icy streets, excessive temperatures, building work being done next to our home, strong winds, power cuts or cuts in the gas or water supply, poorly-placed street furniture, muddy parks, badly-parked cars, the introduction of new technology which we don't know how to use and which makes us feel clumsy or ill-prepared, etc.
- b. Changes in the individual: illnesses, allergies, a broken arm or leg, conjunctivitis, burns, swellings, etc.
- c. Changes of our circumstances: pregnancy, looking after a baby, caring for an adult with mobility problems, living far from a town or city centre, etc.

Thus, by building environments with diversity in mind we actually help our own lives, irrespective of the stage or the circumstances in which we find ourselves, because we all come to differ with respect to ourselves.

GERONTECHNOLOGY AS A FRIENDLY TECHNOLOGY FOR THE AUTONOMY AND THE HOME CARE OF ELDERLY PEOPLE

A new science, the "Gerontechnology", is discovering new technical and engineering applications to save, increase and integrate the autonomy and the quality of life of elderly people, particularly those, who are living at home. Thanks to the collaboration between engineers and geriatrics, the home assistances and cares could utilize equipments especially designed for such purpose: from the aids for ADL (Activity Daily Living) and furniture, to sport units for light fitness. Even those of hospital and medical care, from intensive care to rehabilitation. Also the town-planning is looking at new realisations for elderly people: new vehicles admission, special cars, bicycle, motorbikes, taxi bus; new urban park and facilities etc.

Up to dated researches demonstrated that the elderly people will not depend from technology but will be able to "communicate" with it. On the other hand, the elderly who is cared at home reduces infections and comorbidity and takes advantage from the familiar environment.

A new professional, the "Social-Medical Planner" is now available to integrate Architects and Engineers in the projects of nursing homes and rehabilitation centres as well as private home adaptation for disabled people, elderly included: the "smart house" and other modern examples should be shown.

Further our experience, we are realising that the Italian health and social assistance as well as other Countries, is already able to integrate, in his policy, this concept for a better Quality of Life of all the elder: young old, old-old and oldest-old!

Dario Bracco - Member of the International Society of Gerontechnology - President of the Centro Ricerche e Relazioni Cornaglia (member of AGE-Platform Bruxelles) - fax. +39 011 610780 - email: ricerchecornaglia@tiscalinet.it (read more about this at www.eca.lu)

Dimensional, perceptual, motor and cognitive diversity

Everybody happens to have temporary problems interacting with the environment, but it should be remembered that such problems are often permanent (from birth, or following an accident or illness, for the rest of someone's life):

- **Dimensional diversity:** it is a fact that there are dimensional differences between people: height, weight, width of shoulders, length of the hands and feet, etc.

These differences can be measured using quantitative values in order to draw up anthropometrical population tables.

Often, such tables are used to design products or spaces that have to be used by the whole population.

The problem is that if we only use the central values of the table (the arithmetic mean) we will end up with products, services or environments that can only be used by a small sector of the population.

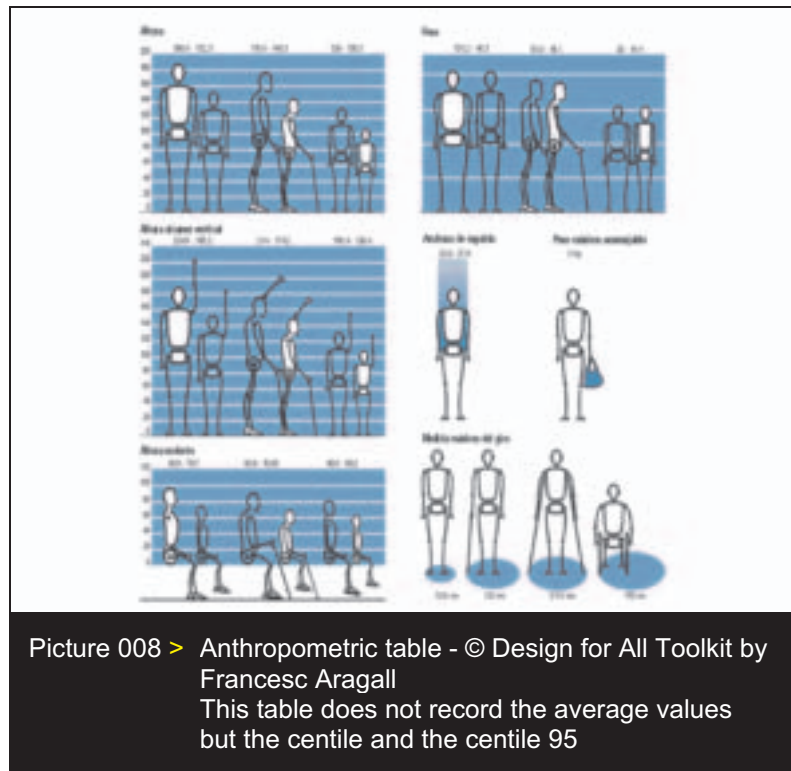

This is because both the lowest and the highest values reflect real characteristics of at least one person of the group; they are not values which have been randomly placed there by the researcher and therefore they should not be ignored.

Thus, designs respecting dimensional diversity should be suitable for both the largest and the smallest people, and this can be achieved in four different ways:

1. A single design that is valid for everybody: for example, making doorways wide enough for anyone to pass through them, regardless of their body size, the fact that they are carrying something or that they are in a wheelchair.
2. Designing a range of objects which covers all possibilities, for example, in clothes' sizes.
3. Designing a product that is adaptable to different dimensions, for example, a chair whose height can be adjusted.
4. Designing an accessory that adapts itself to an original design, for example, car seats for children.
 - **Perceptual diversity:** except for blindness, perceptual problems usually go unnoticed by most people and this often leads to unconscious discrimination against the group in question.

The loss, to varying degrees, of sight, hearing, smell, taste or touch leads to daily problems of interaction with the environment and may create significant hazards:

- For people who wear glasses rainy days present a big problem as wet lenses mean reduced vision.
- Reading the information about a specific bus or metro route may require a great effort for people with poor vision.
- When we shout at someone to warn him/her of some danger, we don't stop to think that this person might be deaf.
- People who lose the sense of smell (due to old age, a cold or an allergy) may not be aware of a gas leak until it is too late.
- The loss of the sense of taste may lead us to eat food that is unfit for consumption.

When we have an altered sense of touch (due to illness, old age or low temperatures) we run the risk of causing serious burns to the skin or mouth.

Thus, in addition to have perceptual diversity in mind when designing environments, it is essential to make the population aware of such problems and encourage respect towards people who suffer one or more of them.

- **Motor diversity:** in referring to people with mobility problems we normally think of wheelchairs and crutches. However, there is a large variety of motor problems which go unnoticed:

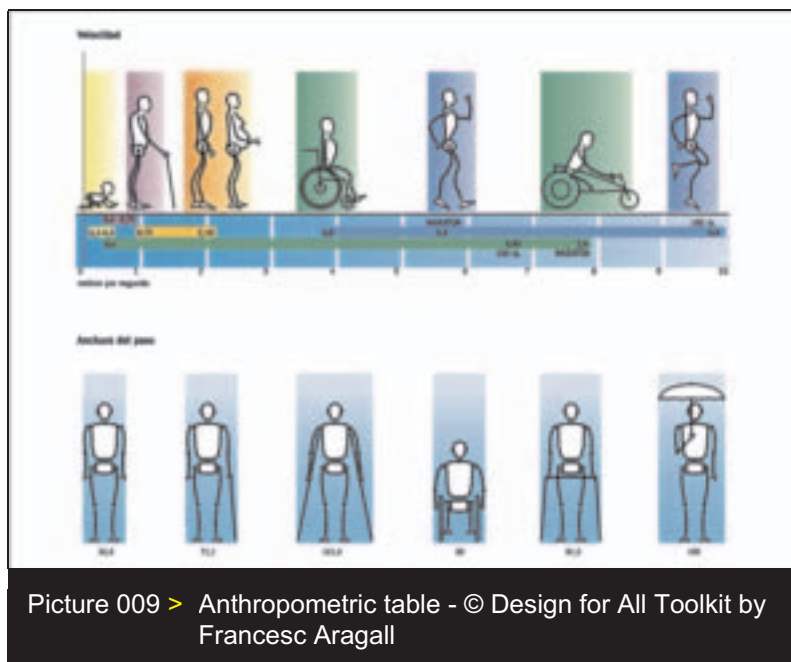

Picture 009 > Anthropometric table - © Design for All Toolkit by Francesc Aragall

- People who walk slowly need longer to cross the road at traffic lights.
- People who have problems lifting their legs find it very difficult to climb stairs or get into a bus that doesn't have a low floor.
- If we have mobility problems in our arms we may not be able to use a switch that is situated at a certain height.
- Those who have difficulty in moving their neck may be prevented from looking up or at the ground.
- People who find bending difficult may not be able to tie their shoes or use a public telephone that is not at their height.
- Problems with manual skills may prevent or hinder the handling of small objects.
- Left-handed people have difficulties using tools designed only for right-handed people.

Therefore, although 'environments for all' should be designed with wheelchair users or people on crutches in mind, it should also be remembered that there are other less visible mobility problems which are equally problematic when it comes to interacting with the environment.

Designs that are not well thought out may favour one group to the detriment of another: for example, escalators are fine for some people with mobility problems in their legs but are inaccessible to wheelchair users.

- **Cognitive diversity:** cognitive changes may affect our ability to receive and process information, our memory, spatial and temporal orientation and speech. Therefore, they directly affect behaviour and the information we receive from the environment.

It should also be borne in mind that cognitive changes are not solely the result of learning disabilities or senile dementia, but may often be a temporary response to stress or depression.

Cognitive changes include the following:

- Memory disturbance.
- Problems of spatial orientation.

- Problems of temporal orientation (when the internal clock which tells us when to eat or sleep, or indicates the time of year, ceases to function).
- Difficulty in remembering the steps required to solve a problem.
- Inability or difficulty in speaking, reading, writing or understanding words (depending on the location and extent of an injury).

DESIGN FOR MENTAL AND COGNITIVE IMPAIRMENT

To date, most of our attention in Europe has been directed at Design for Physical Impairment. Progress has been slow - too slow.

If we can arrive at a consensus on European Technical Harmonization, we should expect to see a marked acceleration in momentum over the next 2-3 years.

A concerted effort should commence now, however, with regard to Design for Mental and Cognitive Impairment.

A distinction has to be made between the two impairments ...

Cognitive Impairment: A deficiency of neuropsychological function which can be related to injury or degeneration in specific area(s) of the brain.

Mental Impairment: A general term describing a slower than normal rate in a person's cognitive developmental maturation, or where the cognitive processes themselves appear to be slower than normal - with an associated implication of reduced, overall mental potential.

In building design and detailing, opportunities to depart from the "straight line" and "right angle" should be fully explored. A building's internal spaces should be designed or modified to be of human scale; its general arrangement, layout and facilities should be easily understood by building users; and a ready connection with the exterior should be provided throughout its extent. The building's associated external spaces should be properly designed for a person to find his/her orientation in a building without difficulty. The building's circulation spaces should be well lit, and should be designed to positively encourage social interaction. Good architectural design and immediately understandable sensory cues should be used in preference to signage. Adequate provision should be made for people to personalize their educational/living/work spaces, and to control the environmental conditions within other spaces.

Research will have to move to another level, where the relationships between neuroscience, human behaviour, and design of the "built/virtual" environments must be observed, explored and tested.

A wider, more multi-disciplinary approach to accessibility will also be required in future ... involving people from the disciplines of neuroscience, psychology and sociology.

C.J. Walsh (visit www.eca.lu to read more about this)

Demographic diversity

Europe's population tends towards cultural and functional diversity: this is due, amongst others, to increased immigration, an ageing population, and another approach to disability. Therefore, there is a need to create environments which are accessible to all, irrespective of their ability or cultural background.

If this is not achieved, there will be a risk of unbalance where the active sector of the population will decrease. This sector has not only to assure social wellbeing of the whole population, but also to compensate the lack of accessibility in our environment, for example:

- People with reduced mobility who cannot get around unaccompanied;
- Adults of working age who can't work because the environment is not adapted to their disability;
- Children who go without schooling because they are unable to access the building or because educational material is not adapted to their needs;
- Urban centres that are overpopulated as a result of poor communication networks;
- Districts or sectors of the population that are marginalized or poor because they are unable to access new technology;
- Families who are not integrated into society due to their culture, language or beliefs.

The factors which are making Europe's population increasingly diverse are quality of life, immigration, birth rate and civil rights

1. A better **quality of life** enables us to live longer. Considered in isolation this may seem to be a disadvantage for the future, in that for society an ageing population implies an extra burden for both the State and for families.

However, improved quality of life means that a large number of people over 65 are in good health and continue to show vitality. Therefore, if environments are built with diversity in mind these people will go on being independent and offer an important service to society (they are knowledgeable, they have many years of experience, time, and above

all they have the desire to go on being useful and the need to still be themselves).

2. **Immigration:** The need for workers and territorial imbalances are producing a rapid rise in immigration in all countries. Although this is a new phenomenon in some European countries, in others it began a long time ago. So, we find people and families of different cultures who are part of the population of that country (many were born there).

Thus, when creating environments, it should be remembered that Europe's population is tending towards cultural globalisation and, therefore, all towns, cities and countries have to set up mechanisms which enable the integration of any person, regardless of culture or background and provide access to the same opportunities and rights.

3. The individual need to develop all our personal abilities and the wish to provide our children with all the necessary elements for their own successful development (school, out-of-school activities, technology, etc.) have a direct effect upon the **birth rate** (nowadays, few couples plan on having two or more children).

AGE AND ATTITUDES – MAIN RESULTS FROM A EUROBAROMETER SURVEY

http://europa.eu.int/comm/eurostat/Public/datashop/print-catalogue/EN?catalogue=Eurostat&product=KS-NK-03-002-__-N-EN&mode=download

In summary, population diversity is the result of people living alongside one another: all of us have the right to a dignified life.

Thus, the choice is clear: either we create environments for all or, in the future, few people will be able to make use of them.

The richness of diversity

Population diversity is the result of people living alongside one another and everybody has the right to a dignified life. If this is the case, the least we can do is demand, and work toward creating, environments which reflect social reality.

Human co-existence is based on mutual respect and the desire that people develop as autonomous individuals.

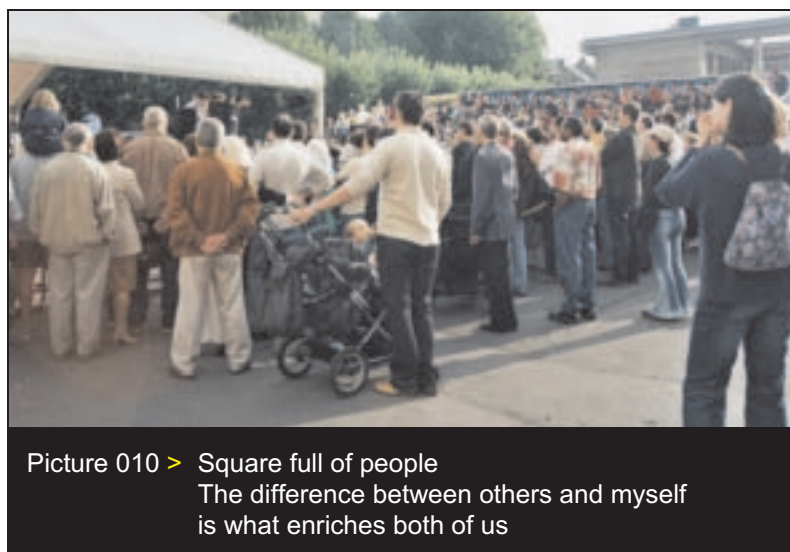

Living alongside one another in this way enables us to learn and benefit from other people's realities and, therefore, the more diversity there is around an individual, the richer his own life will be.

Thus, dimensional, perceptual, motor and cognitive diversity have to be taken into account when developing environments because everybody has the WISH, the NEED and the RIGHT to be independent, to choose his/her way of life and to live it without the environment putting barriers in his/her way.

Although it is often essential to design specific help for specific problems (for example, glasses, wheelchairs, crutches, hearing aids) the fact remains that accessible environments are a determining factor in personal autonomy (where people don't need the help of others to go about their daily lives): the more accessible the environment, the less technical help will be required.

To speak of autonomy or independence in daily living means that the life journeys of all people should be made accessible.

The term life journeys refers to that set of routes which people cover each day in going about their daily activities (for example, going to work or school, shopping, taking children to the park, meeting up with friends).

Therefore, accessible environments should include:

- A public transport network that meets the needs of the whole population in terms of routes, timetables and accessibility of vehicles.
- Clear information that can be easily understood by any user of the environment. This includes reliable signage and guidance systems.

- Rest areas so that people can choose between walking or using public transport.
- Public buildings and the services they provide that are accessible to everybody. This includes friendly and competent service and management.
- A relationship between vehicles (whether parked or in motion) and pedestrians which is amicable and respects the diversity of different users.

Making environments accessible means making them respectful of people's needs and, in turn, encouraging people to respect their environment.

Thus, creating environments with dimensional, perceptual, motor, cognitive and cultural diversity in mind breeds solidarity and facilitates interaction among us. Moreover, it is a definitive step toward equal opportunities, that is, it offers all of us the possibility of exercising our right to the life we want, to be independent, autonomous..., to be a person!

Future trends and lifestyles

With respect to human diversity, environments created by people for people should meet our needs throughout the whole of our lives.

However, we should not forget, that the children of today, their children and their children's children have to live in the future, and need to find that the environment fosters quality in their lives.

Thus, the concept of expiry has to be replaced with one of continuity, the idea of local culture has to be superseded by cultural diversity, blind consumerism should give way to intelligent consumption, creating for the present has to become creating on the basis of sustainability, individualism has to be supplanted by cooperation and solidarity, new technology has to become technology for the people and, finally, the idea that there is stage during which individuals are productive has to be discarded in recognition that there is meaning to the whole of our lives.

Social changes, however, do not come about unaided. There is a need to raise individual awareness, to educate and motivate people so that they give the best of themselves.

Creating accessible environments fosters our co-existence and respect for one another on the streets, at work, in schools, shops, homes, parks.

Accessible environments must be created respecting the universal principles of sustainability. If they are not, what kind of planet, what quality of life will our children, our grandchildren - future generations - inherit?

SUSTAINABLE DESIGN – A WISE POLICY

Sustainable development is not just about clean water and renewable energy: ... it is a holistic way of thinking - a long term strategy, which must embrace the human life cycle... It has become a core concept in all forward-looking political strategies.

Karin Bendixen in "Form & Funktion - Nordic Design for All Magazine" No. 2/Volume 1 December 2002 (<http://www.dcfk.dk/index.asp?pid=1930>) (visit www.eca.lu to read more about this)

OPPORTUNITIES

Assuming that accessibility consists of providing an environment that everybody can enjoy, its most immediate effect is a greater number of people able to participate in social and economical activities.

To increase accessibility in buildings, products and services generates a win-win situation, where friends and relatives of people who experience difficulties in non accessible environments, tend to become users and clients of those with a welcoming access for such people. Does not this conception then mean an investment, instead of a expenditure for society?

Opportunities for users

Any design aimed at someone with a disability will be easier to handle or use for the rest of the population.

Accessible environments are undoubtedly of benefit to all of us:

- We have no problems putting our rubbish bags into street containers.
- The bus we take to work has a low floor.
- We do not come across obstacles on the pavement when we go for a walk.
- We receive both visual and audible information.
- The instructions for use of a domestic appliance are clear.
- We can use the various services available in our area without problems.
- Children can play in the park without being exposed to risk.

Furthermore, when we, as users, find that an environment improves our quality of life, we are more likely to respect and take care of it.

Opportunities for designers

Design errors are often due to the fact that designers take as their model user either themselves or the people whom they normally come into contact with, thus forgetting the real diversity of the population.

However, those who design from a perspective of accessibility will find that their projects are more successful because the final result will be a design that is valid for the majority of people.

Accessibility or design for all should be a philosophy that is adopted by all those involved in the creation of environments or the development of products aimed at the general public.

Therefore, it is essential that both professional bodies and universities promote this concept and provide experts with the information they need to put it into practice:

1. **Universities**, as centres which train and guide the next generation of experts, have to ensure that the knowledge they impart is based on this philosophy. In order to motivate students to take it on board and to continue with this line of work, the whole of the university environment has to be a real life example of the philosophy it is aiming to promote; that is, anyone who so wishes should be able to access its different services (lecture rooms, toilets, cafeterias, libraries, etc.).
2. **Professional bodies** should make their members aware about new trends, the tools to be used, the social benefits that these bring and the professional success that follows from accessible designs.

In summary, universities and professional bodies should support the **social commitment** of designing for the whole population and, moreover, should themselves make a **professional commitment** to motivating and educating their students or members.

UNIVERSAL DESIGN CONCEPTS IN CURRICULA

Architectural obstacles and barriers in the built environment still exclude many people with disabilities from full and active participation in the life of the community – a form of social exclusion that is unacceptable.

Key players in the fight for creating accessible built environments are, of course, all occupations shaping that built environment as part of their everyday professional routine. As training is a well-recognised motor of change, their education and training is of utmost importance when striving for accessible environments, either through the removal of existing obstacles or the avoidance or creating new ones.

Already in 1977 the Council of Europe in Strasbourg adopted *Resolution AP (77) 8 on the adaptation of housing and surrounding areas to the needs of disabled persons*,

which recommended “widening the scope of education and information provided for those engaged in the house-building process to include teaching of the problems outlined and their possible solution”.

The accompanying report, revised in 1979, contains some 30 pages of relevant technical dimensions, meant as working examples rather than compulsory standards, since it was difficult to reach consensus amongst member states on what may have become European standards. Repeated attempts during the 1980s to push the matter forward failed but led to the publication of the report *Accessibility – Principles and Guidelines* in 1993. The report promotes the concept of “integrated accessibility” and stipulates: “It is important that the concepts of integrated accessibility and interactivity are incorporated into architectural education”.

During that time, the Council of Europe’s Committee on the Rehabilitation and Integration of People with disabilities (CD-P-RR) made the training of staff concerned with the rehabilitation and integration of people with disabilities one of its priorities.

Recommendation No. R (92) 6 on a coherent policy for people with disabilities states: “For the purpose of taking early action to promote a radical and coherent policy for accessibility, the concept of integrated accessibility should be at the roots of the basic training syllabus for architects, town planners and engineers.”

In the late 1990s, it launched an initiative concerning the training of architects, engineers and town planners, which, eventually led to the adoption of *Resolution ResAP (2001) 1 on Universal Design*.

That Resolution aims to improve the accessibility of the built environment by recommending the inclusion of the principles of Universal Design into the curricula and training of all vocations working on the built environment, in particular architects, engineers and town planners.

It takes a pro-active approach to tackle the problem of inaccessibility by aiming to improve the education and training of all professions working on the built environment by directly addressing governments, and indirectly universities as well as institutes of further and vocational training.

What is new about the Universal Design approach?

The man-made environment is constructed on assumption of there being an “average person”. In the past, the problem of accessibility was considered a direct result of the individual’s deviation from “the norm”. The person was “the exception”, hence “the problem”. Following an itemized approach, the most common response to accessibility problems has been to add special facilities to an existing building, such as ramps or wider doors. This response, however, reinforces the idea that certain individuals are “exceptions to the rule” and stigmatises them by obliging them to use,

for example, separate entrances, often at the rear of the building. Furthermore, most of those modifications are add-ons, following some afterthoughts, rather than results of a planned design process.

Now, the new integrated approach including Universal Design aims to respond equally to the needs of everyone. Everyone should be able to enter and use any part of the built environment as independently and naturally as possible. The criteria defining “normality” should be enlarged to ensure that the construction of the built environment is based on Universal Design principles. A new awareness of design and construction is needed.

To that end, the Council of Europe Resolution ResAP (2001) 1 on Universal Design takes as a starting point the right of all individuals to access, use and understand the built environment and the responsibility and duty of society, in particular architects, engineers and town planners, to make that possible.

Aware of the ongoing discussion amongst expert circles, it was decided, however, that for the purpose of the Resolution the terms “Universal Design” and “Design for All” are used synonymously.

It is recommended that the concept of Universal Design should be an integral and compulsory part of the mainstream initial training of all occupations working on the built environment, at all levels, and in all sectors.

The recommended measures are set out in 10 chapters: General principles; Definitions; Aims objectives and strategies; Higher education; Further education and vocational training; Teaching methods and materials; Training of trainers; User participation; Evaluating teaching effectiveness; and International exchange of information and good practice.

Mr Thorsten AFFLERBACH, Administrative Officer, Integration of People with Disabilities, DG III – Social Cohesion, Council of Europe, Strasbourg, France (visit www.eca.lu to read more about this)

Opportunities for property developers

Private individuals or bodies who promote accessible projects will find that they have a stronger sales pitch and, moreover, that it has a more human quality.

For example, when selling a property they will not have to restrict themselves to talking about aesthetic aspects, the number of rooms or the prime position (near a beach or gardens, etc.), but will also be able to draw upon the following arguments:

- Accessibility of the property in itself: it is suitable for anybody.

- Accessibility of the surrounding environment (services, green areas, transport).
- Flexible living space that can be adapted to the different needs of the people who inhabit it.
- Use of hard-wearing materials produced by environment-friendly methods.
- Aesthetic appeal and good taste sought within functionality.

In this way, promoters are likely to feel personally satisfied as a result of being able to offer a quality, long-lasting product that is suitable for the majority of people.

Since 1973, the European Commission has been monitoring the evolution of public opinion in the Member States, thus helping the preparation of texts, decision-making and the evaluation of its work.

Our surveys and studies address major topics concerning European citizenship: enlargement, social situation, health, culture, information technology, environment, the Euro, defence, etc.

http://europa.eu.int/comm/public_opinion/

Opportunities for business

The companies which develop projects are themselves created entities. Therefore, if their projects are to be accessible it is essential that they are too.

An accessible company is one which takes diversity and its employees' quality of life into account. When this is the case, employees feel treated as people, they are motivated and concerned to ensure the smooth running of the company.

Accessible projects are designed with the whole population in mind; they generate an increased number of consumers and, consequently, greater commercial opportunities.

Furthermore, accessible projects are likely to generate new business, for one of the maxims of Design for All is the creation of environments which can be adapted to different requirements.

For example, a hotel in a prime position overlooking the sea does not have to restrict its season to July and August if the adaptability of its space provides different business options throughout the year:

- The hotel management could negotiate with the local town council in order to organise sporting activities on the beach, those which are possible even when it is not the season for water sports.
- Hotel rooms could be used for out-of-school activities for children and teenagers.
- The hotel could help with organising local festivals and provide a pleasant space for holding cultural and community events.
- If there is a heated swimming pool this could be used for swimming lessons.

Hotels which are not accessible may miss the opportunity to accommodate a large group of guests, among whom there are people with some form of disability.

The fact that all a hotel's facilities are accessible is a good reason to have elderly guests throughout the year, as their holiday periods are more flexible.

Through activities like these it is possible to maintain a largely permanent staff and thus avoid the need to find new employees each season. It also makes better use of the facilities and is a way of attracting both local and visiting customers all year round.

TOURISM PLANNED FOR ALL - DEMANDS AND OPPORTUNITIES FOR TOURIST DESTINATIONS IN EUROPE

The demographic development of the society will have a great impact on tourism-industry in Europe. As the number of older people as well as the number of disabled people increase it is indispensable that tourist destinations make offers according to the needs of these customer groups, too.

The creation and designing of an accessible, spacious, and comfortable environment should be regarded as a sign of quality, which will make journeys and holidays more convenient and pleasant not only to older or disabled people. An accessible destination will fulfil tourist wishes like comfort, time-economy and reduction of stress. By establishing the concept of "Tourism planned for All" as a criteria of quality and comfort an increase of recreation and recovery will be achieved. Every guest and tourist will benefit from this concept in the end.

Dr. Peter Neumann (visit www.eca.lu to read more about this)

Another example is the case of big shopping areas. They are designed from the beginning to facilitate access by leaving sufficient space between parking places or public transport and buildings, as well as avoiding steps on the way from the halls of the buildings to shops and services.

Probably it was this conception of accessibility that has largely contributed to the success of shopping and leisure centres.

Similarly, the companies that have integrated this philosophy into their products and services have experienced an increase of their profits. (Some examples can be found on the website).

And there are many other examples in tourism, housing, personal hygiene products, etc.

Finally, as in the case of promoters, those employers who make a commitment to design for all will have the personal satisfaction of improving the quality of life of employees and consumers.

COMMITMENT TO DESIGN FOR ALL

The Design for All Foundation has developed a scheme to make Design for All compatible with profit. Through the Commitment to Design for All, companies improve the accessibility of their products and services and at the same time, improving their social image, increasing their number of clients and user satisfaction.

Imma Bonet, Executive Patron of the Design for All Foundation (visit www.eca.lu to read more about this)

Opportunities for politicians

Politicians who strive to make environments accessible to all are demonstrating their desire to offer the population a good quality of life and provide people with better opportunities to develop, both socially and personally.

It should also be remembered that it is politicians who are responsible for public spending. In this respect, making environments accessible has a direct effect on public spending:

- Hazardous situations, and therefore the number of accidents, are reduced in accessible environments.
- When interaction with the environment is easy there is less need to provide individual assistance (whether by other people or through designs which compensate for environmental deficiencies).

Finally, accessibility makes towns and cities more attractive for the people who live in them and for potential visitors (tourism) - not to mention those companies or professionals who are looking for a suitable environment in which to set up their business (progress).

The more accessible the environment becomes, the better the resources saved as a result may be used.

Such is the case of the saving produced in door-to-door service provided public transport is accessible.

Another example: the cost of an elevator in a three-story house equals that of person staying in an institution for 2 years.

NEED FOR LEGISLATION TO CREATE ACCESSIBLE ENVIRONMENTS FOR EVERYONE!?

One of the most obvious and difficult problems for many disabled people is the physical inaccessibility and non-usability of the built environment. Accessibility is one of the decisive issues for (the degree of) participation and integration of disabled people (and often of their family and friends as well!) in society. The struggle for equal opportunities and the growing (political) awareness that the accessibility of public buildings, houses, public transport etc.. is a basic right, is becoming more and more common, especially since the publication of the Standard Rules on the Equalisation of Opportunities for Persons with Disabilities of the United Nations (rule nr. 5 on Accessibility). This development can be considered as one of the most important achievements on issues pertaining disabled persons at the international

level. Although these rules still play an important role in influencing the promotion, formulation and evaluation of policies, plans, programmes and actions at the national, regional and international levels, they however do not have a legally binding nature.

In many countries all over the world, also in Europe, national legislation is considered to be one of the main tools to get an accessible society. This is the case in many European countries for already many years. Also the European Commission, the European Parliament and of course the European Disability Forum discovered more recently that European legislation on Accessibility is possibility to push with both hands. European legislation on Access is on the Political Agenda and for many Eurocrats - supporters of a federal Europe - if you like that better, this cannot be left to the memberstates of the EU. It seems that subsidiarity is out!

Maarten van Ditmarsch (visit www.eca.lu to read more about this)

CHAPTER 3

RECOMMENDATIONS FOR ACCESSIBLE ENVIRONMENTS

INTRODUCTION

This chapter analyses the different elements which form part of the built environment.

The aim is to provide some examples of guidelines to adjust the design of spaces and services to the needs of human diversity.

Nevertheless, the detailed plan and conception must take into consideration also the specific local situation and resources.

The examples, that are provided here refer to:

- Open spaces
- Transport
- Public buildings
- Housing
- Public information services

They should be used as a source of inspiration and completed according to the considerations made in the preceding pages.

OPEN SPACES

Thoroughfare

For the thoroughfare to be accessible there should be a functional relationship between all those elements of which they consist, such as street furniture, vehicles and café terraces, because any badly-placed element (for example, a car parked on the pavement) may prove to be an insurmountable obstacle for some people. Therefore, in addition to raising public awareness about the need to respect the functionality of different areas (such as those designed for pedestrians, leisure or parking), the design of public streets and sidewalks should also include elements that prevent those spaces from being used incorrectly - always ensuring, of course, that these elements are not themselves an obstacle.

The development of society has sometimes worked against quality of life, as is the case of the increased number of vehicles in cities which come to take up space that was originally meant for people. Thus, it is important that the development of the environment is planned in a way that admits progress without giving up quality of life. What is needed, therefore, is for vehicles and pedestrians to co-exist in a correct and amicable way. Depending on the specific situation, this may be achieved by:

- Removing traffic from certain streets or areas of the city.
- Restricting traffic to vehicles belonging to residents in areas where there is housing but where through-traffic is not advisable (such as the old part of certain towns).
- Removing sidewalks from narrow streets frequently used by pedestrians.



Picture 011 > Narrow street with sidewalks

- Distinguishing pedestrian areas (pavements) clearly from the road, analysing the proportion that each space should have.
- Creating car parks or areas for parking and loading/unloading in a way to prevent stationary vehicles from taking up pedestrian space.



Picture 012 > Removing narrow sidewalks benefits anybody

The elements of the thoroughfare itself will be divided into two groups: common urban elements and elements of street furniture.

1. Common urban elements

Common urban elements are those which do not, or should not, protrude above the surface of the road surface (for example, garage entrances, drain openings, gas or water piping, and meter covers).

Advisable measures to be taken into consideration when designing and placing common urban elements are as follows:

- Apart from garage entrances, they should be completely level with the road surface so as to avoid people tripping or falling over them.
- Common urban elements should be designed so that they fulfil their purpose without being an obstacle or posing a risk.
- Drain openings should be of a size that enables large amounts of water to pass through them, but their design should be such that neither a child's foot, shoe heels or crutches fit through them, nor that vehicles with small wheels (babies' prams, the front wheels of wheelchairs) become stuck.
- Elements placed beneath the road surface (piping, or electrical or telephone installations) will need to be repaired or replaced one day. This work should create the minimum of inconvenience to the public.

These aspects should be considered when work begins, as correcting them later proves expensive.

2. Elements of street furniture

Elements of street furniture are those which are placed in the public streets and sidewalks with the aim of providing a service to people: benches, street lamps, litter bins, traffic lights, bus shelters, information posts, etc. As a rule, these elements have to be aligned with and placed on the edge of the pavement (next to the road), and, moreover, they have to reach the ground so that visually-impaired people can detect them with their sticks.



Picture 013 > Elements which are not aligned with and placed on the edge of the pavement can be the cause of an accident or disorientation of visually-impaired people

The aspects to be considered when designing them will depend upon the element:

- Benches: should enable people to sit comfortably and, subsequently, get up without difficulty. Therefore, they should be of a suitable height and have arm rests.
- Parking meters: should be easy to use. The likelihood that users will not always have coins should be foreseen.
- Containers: should be totally accessible so that people with mobility problems do not have to leave their rubbish outside the container.
- Trees: should not be placed in narrow streets and care should be taken to ensure that the lowest branches do not pose a risk to taller people or high vehicles.
- Information signs: should be placed at a height that allows them to be read without blocking people's right of way.
- Protective elements in squares and pedestrian streets: should not be low elements like concrete balls on the ground that may pose a risk, especially in areas where they may become completely covered in snow.
- Information: which refers to temporary risks (slippery surface, danger of falling material, wet paint, etc.), should be comprehensible to anybody.

- Poor visibility: should be compensated, for example in towns where it is often foggy, street furniture should be fitted with fluorescent markings.

In addition to the above, it should also be remembered that there are elements in the public streets and sidewalks which are privately owned - such as café terraces, shop awnings and doors to buildings - and therefore it is necessary to draw up clear regulations which should always be complied with.

THE SIGNIFICANCE OF GLOBAL POSITIONING SYSTEMS FOR THE REDUCTION OF MOBILITY BARRIERS FOR BLIND AND SEVERELY VISUALLY-IMPAIRED PERSONS

The "barriers" reducing the mobility of blind and visually-impaired persons are caused primarily by problems of orientation and a lack of information. For instance, virtually no cities have suitable maps (the relief maps available for a small number of cities are in fact virtually unmanageable for most persons concerned). Orientation en route is made more difficult by the fact that road signs are inaccessible for blind and severely visually-impaired persons. The existing approaches towards solutions are restricted to individual guiding grooves for the blind affixed to edges of individual railway platforms and audio traffic guide equipment at traffic lights, and hence serve to avoid danger.

A satellite-guided navigation system (GPS) equipped with a speech synthesizer would make it possible to identify and announce the current position in a city, but the user would still not receive any information about the route to be taken. In order to improve the mobility of blind/visually-impaired persons, therefore, the addition of a "route planner" is indispensable.

Additionally, a GPS which is intended to reduce the barriers to mobility faced by blind/visually-impaired persons would need an input interface in order to be able to accept additional information that is important for orientation/mobility. This includes for instance the position and type of road crossings (zebra crossings, traffic lights - with and without audio traffic guides - and subways), the position of bus stops, and the departure times of all public transport at the stop in question.

Furthermore, this interface would make it possible for any user to store the positions of specific shops, doctors or other important destinations that are important to them.

Such navigation systems, were they to include a route planner and the necessary additional information, would provide a valuable contribution to making mobility easier for blind and visually-impaired persons. They supplement, but do not make superfluous the existing aids such as long canes and guide dogs. A long cane and a guide dog have in addition to markings in road traffic primarily the function of circumnavigating obstacles and avoiding dangers. Supplemented by the orientation possibilities provided by GPS, these aids could be much better used.

Worldwide, many organisations are evidently working currently to make GPS useable via speech output. There is good reason to hope that Papenmeier Rehatechnik will be selling the system developed in Canada by Visuaide in Germany this year, although currently it does not contain a route planner.

Dr. Rüdiger Leidner (visit www.eca.lu to read more about this)

Street maintenance

The design of streets and urban elements located on them defines the accessibility degree of the street. But although the design was good, there are times that the maintenance activities or the lack of maintenance can seriously affect the accessibility, i.e.:



Picture 014 > Bad protected works
In such situations, the risk of accidents
is very high

- The maintenance works in the sidewalk has to foresee the proper signalling, protection with fences and provisional accessible ways.
- The damaged urban furniture can cause an accident if dangerous parts are exposed.
- The rubbish can be an obstacle and a danger if the street is not cleaned so often or the containers are not big enough.



Picture 015 > Buried container with accessible mouth
Solutions should be designed to allow everybody to participate in the recycling process

Finally, in order to encourage everybody to collaborate in the materials recycling, containers have to be accessible for all the citizenship without forgetting children and the elderly.

In short, good co-ordination and functioning of cleaning and maintenance services are the key to a safe environment, one in which people enjoy a good quality of life.

Recreational areas

Parks and gardens are spaces given over to leisure activities and meeting other people, as well as being the lungs of heavily built-up areas. The aspects to be taken into consideration when designing them will depend on their size, location and the number of services they offer.



Picture 016 > ... lungs of heavily built-up areas

The measures to be taken into account when designing a small park or square situated at the heart of a district are as follows:

- Parks or squares whose surrounding streets are open to traffic have to be fitted with safety fences to prevent children from running into the road.
- There should be an area set aside for very small children in which they can play safely.
- Benches should be installed next to the play areas so that adults can sit down while watching their children.

In the case of larger spaces whose interior contains a variety of different service areas, safety, accessibility and signposting measures should all be taken into account:

- There should be a map at park entrances which indicates the location of the various services, activities or equipment, and provides information regarding opening times of the facilities and different guided activities.
- The paths which form the different routes should intersect, enabling users to easily change from one to another; avoid the use of steps to change from one level to another.
- As in small parks, the space for children's play facilities should be designed with the accompanying adults in mind.
- Playgrounds should respect the diversity of children (age and mobility).



- The design of play facilities has to ensure the safety of the children using it, without forgetting that children need and want to experience new sensations.
- The materials used to build these facilities should not become dangerous in the event of breakage.
- The elements of furniture (benches, fountains, litter bins, etc.) should be placed in accessible locations, but not represent an obstacle for people who are out for a walk.
- The materials used in building the furniture should enable it to be used continuously without the need for constant maintenance.
- In areas set aside for rest and play facilities, the vegetation should provide shade in summer and let the sun through in winter.
- Sanitary and hygiene aspects arising from the presence of animals (pets) should be taken into account.
- Indoor facilities (such as toilets, theatres and bars) have to be totally accessible.
- In parks that are not within a closed site, and which are therefore open at night, it is important to intensify cleaning measures so as to avoid children playing with syringes or broken glass left lying around.

Thus, when designing a park we have to remember that it is a space meant for leisure activities and, therefore, it requires more cleaning and maintenance than other urban areas which are less heavily used.

The use made of beaches along the seaside, rivers or lakes has changed over the years, developing from a purely commercial relationship (fishing and trade) to one based around leisure. Therefore, beaches have ceased to be natural spaces and have become urbanised ones; this is especially the case of those which form part of a town centre and where changing huts, bars, Red Cross huts and other services aimed at the safety and well-being of bathers have been installed.

Nowadays, beaches are thought of as places to be used by the general public. It is therefore essential that everybody may access them, bathe and take advantage of the different services on offer. As with any built space, the necessary interventions will depend on the specifics of each case, but there is a series of considerations which have to be taken into account when designing Beaches for All:

- Natural agents: the effect of wind and rain have to be taken into account. However, when it comes to placing fixed elements or installing the boardwalks which provide access to the water, it is particularly important to bear in mind the tide, as changes in sea level may be very marked in certain areas.
- Grounds: texture and colour - lighter or darker - change from one beach to the next, but it is always a non-compact or irregular material that is difficult to walk on and can impede the unaccompanied access of wheelchair users. Therefore, boardwalks should be installed which stretch from the start of the beach to the different services on offer (toilets, bars, changing huts, etc.) and end at the water.
- Boardwalks:
 - The fact that people are usually carrying many things (bags, sunshades, etc.) and the possibility of two wheelchairs needing to pass each other should both be borne in mind.
 - They should not be rigid because they have to adapt to an irregular surface; in addition, they have to enable people to step off them at any point along the way.
 - It should be remembered that people walk on them barefoot, and therefore the elements joining the different sections should not be dangerous.



- The design should be studied in detail as using moveable elements to achieve adaptability creates risks (for example,

jamming the fingers of a crawling baby or producing excessive irregularities in the path due to improper use).

- The boardwalk has to begin where the sand starts and end at the sea.
- Building materials: as in the case of public furniture, these have to be weather-resistant, but it should also be borne in mind that they will be in direct contact with salt water and that the people using the different elements will be wearing few clothes, thus increasing the risk factor associated with skin contact.
- Information: given that the structure of one beach may be very different from that of another, it is not possible for them all to offer the same degree of accessibility. Therefore, clear information should be provided regarding the state of each beach and the services it provides, and this should be posted both at the points of access to the beach itself and in other sources of public information (tourist offices, Internet, local council publications). In this way, people can choose in advance which beach they want - and are able - to visit.

Before bringing this section to a close, we would like to add that if the recreational area is genuinely to be a place for everybody, then people should be able to reach it from any point of the city. Therefore, the design should consider the possibility of arriving on foot, or by public or private transport, and has to make provision for parking. Clearly then, a good design for an accessible environment is one which takes into consideration the different urban projects being developed (transport, leisure, culture, housing, etc.) and aims to combine them within an overall vision that ensures the safety and integration of everybody.

PUBLIC TRANSPORT

Whether out of necessity or for leisure purposes, moving around and getting from one place to another is a characteristic of human beings. If we add to this need the growing social ideology of personal autonomy then it becomes clear that any life journey should be made accessible.

Public transport has a very important role to play in making this a reality, and therefore it has to take into consideration the diversity of the population (accessible), cover the mobility needs of everybody (effective), be compatible with the environment (environment-friendly), and be sustainable.

1. Accessible

When designing accessible transport the measures to be taken will depend on the environment and the mode of transport in question (bus, train, underground, etc.).

Thus, we will analyse each transport mode individually:

Buses

- They should have a low floor and a ramp that enables everybody, regardless of their physical capabilities, to get on and off.



Picture 019 > Everybody should be able to use public services

- The interior lay-out should allow passengers to move around and there should be space reserved for specific needs (wheelchairs, pushchairs, bicycles, etc.)
- They should be equipped with an integrated audio/visual system that automatically provides information to passengers.
- In addition, for buses to be accessible, it is essential that bus stops and stations are as well.

Underground, trams and trains

- Vehicles should be designed to enable access by everybody.
- Space should be reserved for the specific needs of certain passengers.

- In stations, the height of the platform should be level with the floor of the vehicle.



- The gap between the platform and the vehicle should be small enough so as not to pose a risk to passengers.
- In the case of vehicles with a toilet (trains), furniture should be limited to essential elements and the interior distribution should be studied so as to achieve the maximum possible space. It is advisable to use sliding doors so that these do not invade interior or exterior space.
- The information provided in vehicles should be the same as on buses.
- Clear information should be provided in stations regarding the layout of the building, the different services and trains (timetables, destinations, platform numbers, etc.).
- In terms of the station's accessibility, those measures described in the section on public buildings should also be applied here, but taking into account that, especially in mainline stations, people will be carrying varying amounts of luggage (use of trolleys for luggage).
- Personal assistance should be available in the wagons (i.e. voice communication with the driver, emergency communication systems, etc.).

Taxis

The taxi is a private form of transport that offers a public service and, unlike other transport modes, it can provide a door-to-door service without depending on timetables and without the need to look for a parking space. The importance of this service should not be overlooked as many people find themselves unable to reach a public transport stop, whether for reasons of mobility or due to other problems, such as not knowing the way or agoraphobia (fear of open spaces).

Therefore, when it comes to designing public transport facilities for a given environment the role of the taxi should be borne in mind. The measures to be taken into consideration are divided into necessary and recommendable ones as follows:

Essential guidelines

- The doorway (height and width) should allow access by anybody, regardless of their capabilities or body size.
- People in wheelchairs should be able to get in and out without getting out of their wheelchair, and once inside should not have to change seats.
- Passenger safety has to be ensured: seat belts in the back, fitted child seat and a system for securing pushchairs and wheelchairs.

Recommendable guidelines

- Taxis should be fitted with an intercom so that passengers do not have to lean forward in order to speak to the driver, and so that the latter does not have to turn his/her head in order to hear.
- The space between the front and back seats should allow people to stretch their legs.
- The driver should be able to make radio contact with someone who speaks the language of foreign passengers.
- It would be advisable to create an information helpline for taxi drivers, to be used while driving around, which could help protect them from the anti-social behaviour of some users and provide information about what to do in an emergency (pregnant woman going into labour, somebody fainting, etc.).



Picture 021 > Accessible taxi

However, it should be borne in mind that a door-to-door service is best used in times of necessity, as walking every day is a healthy activity and using a form of public transport designed for numerous passengers is a more environment-friendly alternative.

Passengers' various needs should be considered in the design of

- Information and booking
- Infrastructure
- Rolling stock
- Operation and services

All elements should be accessible and provide independent travel. Where there are common European standards and guidelines, these should be used (Bus directive, COST 335 for Rail transport etc.).

All general information should be accessible (booklets, Internet etc), there should be information about accessibility and booking routines should identify and take care of disabled passengers' special needs.

Infrastructure like platforms, terminals etc. should be accessible for all and provide level access with a gap less than 5 cm to the rolling stock. Rolling stock should provide space, information and safety for all passengers.

Disability awareness in operation and services is vital, and can be achieved through training and arenas for consulting and communication with passengers.

Finn Aslaksen (visit www.eca.lu to read more about this)

Ports and Airports

The criteria which should be applied to maritime and air transport are the same as those for buses and trains. Likewise, the adaptation of terminals is similar to that of stations, both in terms of information and accessibility, not forgetting that there are procedures which passengers have to carry out prior to boarding (checking-in luggage, getting information about the gate number and departure time, etc.).

The major difference between these transport modes and land-based ones concerns boarding or vehicle access:

- With aeroplanes, the use of fingers is always recommendable as they provide level access on foot and avoid the need to worry about weather conditions (rain, wind, temperature difference between inside and outside, etc.).
- With respect to boats, people with mobility problems should have the option of boarding from the loading/unloading area, an accessible route from here to the main passenger area should be provided.

General

- The payment system for each form of transport should be able to be used by anybody.
- Ticket machines should have an accessible design which includes a suitable height for buttons, the ability to change language, provision of oral, written and Braille information about the steps to be followed and the possibility of correcting a mistake.
- Some way of easily finding advice and general assistance should be provided.

2. Effective

If public transport is not effective, in other words it is not adapted to the mobility needs of users (capacity, timetables and routes covered), then people will end up not using it:

- The public transport network has to cover the whole of a given area.
- The number of stops should be proportional to the size of the area (all users should find a stop nearby, regardless of where they are).
- The number of vehicles should be increased during peak times to prevent crowds making the service inaccessible.

In short, a public transport network that is designed to meet the real needs of users, in terms of accessibility of both vehicles and the service itself, will create friendlier environments as it will reduce the number of private vehicles on the road each day.

PRIVATE TRANSPORT

Although the use of the public transport has to be promoted, we have to bear in mind that some people have mobility problems which oblige them to use a private vehicle. So, it is necessary that:



Picture 022 > Street parking place

- Pedestrian areas should be designed in a way that vehicles - such as ambulances, vans which have to load/unload, or those of residents with mobility problems - can enter: protective elements should therefore be retractable.

- There should be surface level parking spaces reserved for people with reduced mobility throughout the city.
- Users with mobility problems who hold special parking permission should be well-informed about their rights, but also about their duties (parking properly so as not to create risks for other people).
- Rental car companies have to offer adapted cars for drivers with disability.
- To guarantee the complete autonomy of drivers with disability, gas stations should be attended by personnel instead of being only self service.
- In addition S.O.S. points on streets and sidewalks should enable deaf drivers to use them.

PUBLIC BUILDINGS

Many different definitions of what has to be understood by "public buildings" are used. In this document we would like to include in our definition all buildings that are not used for private housing.

These buildings normally house services for the public that, at one time or another, will have to be used by the whole population; therefore, they should be totally accessible. Furthermore, any qualified person, regardless of his/her physical capabilities, should be able to apply for a job within such buildings. It is therefore essential that the whole building, not just those areas for dealing with the public, are accessible (corridors, toilets, offices, etc.).



Picture 023 > Entrance to an accessible public building

Aspects which should be taken into consideration are:

- Entrance: access should be at street level or, where this is not possible, a ramp with a gentle slope should be installed. Alternative entry points should, as far as possible, be avoided, being resorted to only under special circumstances (for example, during building work or when the appearance of a building of historic or artistic value would be damaged).
- Information about the lay-out of the building: in the lobby there should be a map showing the lay-out of the building: number of floors, the floor on which we are at present, location of lifts, stairways, ramps, emergency exits, etc.
- Information about the lay-out of services: next to the above-mentioned information there should be another map showing the different services: number of the floor they are to be found on, office or window number, general information board, etc.
- Guidance systems and/or personal assistance.
- Access to the different areas:
 - Accessible lifts (with enough space and provided with visual, acoustic and tactile information), both for the normal operation and in case of an emergency. Other aspects, like the gap between the floor and the car, or people who suffer from agoraphobia or claustrophobia, should be considered in the lift design.
 - Ramps with a gentle slope.
 - Corridors which are wide enough to enable the various users to pass one another.
 - Office doors should be wide enough to enable anybody to pass through them, and their position should be such as to allow wheelchairs to be manoeuvred.



Picture 024 > Shopping centres became accessible to allow the use of the shopping trolley

- Toilets: There should be enough accessible toilets on each floor with space for wheelchair users, alarm systems and with all the devices accessible both for people of different height and manoeuvre capacities. There also have to be baby changing facilities. These toilets should be cleaned regularly or equipped with auto-cleaning systems.
- Evacuation in an emergency: there are times when lifts cannot be used, either because it is not advisable (fire) or because they are not working (power cut). Therefore, provision should be made for

alternative escape routes and fire shelters. Also, it should be remembered that everybody in the building at such times should realise there is an emergency, regardless of their capabilities (visual and acoustic alarms) and where they are (in the toilets, offices, corridors, cafeteria, lifts, etc.).

PROTECTION FROM FIRE IN BUILDINGS

Protection from fire of People with Activity Limitations (2001 WHO ICF) must be considered at every stage of accessibility design and implementation in buildings. Where practicable, direct and meaningful consultation must be undertaken with each person involved.

In general, the proper fire engineering design objective is independent, multi-stage evacuation to a 'place of safety' which is remote from the building; otherwise, people must be well protected within the building itself.

The following user categorization is helpful in preparing a Fire Safety Strategy ...

- all users with an impairment or health condition ;
- visual impairment ;
- hearing impairment ;
- physical function impairment ;
- mental / cognitive impairment.

It may not be possible to identify each Person with an Activity Limitation. Because of the social stigma attached to disability, some people may not wish to identify themselves. Other people may not realize that they have a health condition or an impairment.

Some Important Design Issues in a Fire Defence Plan :

1. Building 'understandability' ;
2. User orientation, and relationship with the exterior ;
3. Simple, non-conflicting signage, with preference for graphics instead of text ;
4. Alternative means of evacuation ;
5. Fast, reliable fire detection - with warning information which will be easily understood by all building users ;
6. Multi-stage evacuation ;

7. Areas of rescue assistance ;
8. Use of lifts / elevators, escalators and horizontal travelators during a fire incident ;
9. Accessibility of all evacuation routes, including staircases ;
10. Design for firefighter contraflow in evacuation routes, including staircases.

Health can no longer be described as the absence of disease or infirmity, but as a state of physical, mental and psychological wellbeing. The word 'safe' on the other hand, meaning simply un-injured or out of danger, when used in the context of the protection of people from fire in buildings, is entirely inadequate to properly describe the correct fire engineering design objective, i.e. that during and after the process of Independent Evacuation to a 'place of safety', or partial independent evacuation to a 'place of relative safety', or Protection in Place, the health of those people involved, including firefighters, should be assured.

For simplicity, there are three components to fire - heat, smoke and flames.

Because we may be asking people to remain in a building during a fire - far greater reliability is required with respect to all aspects of fire-related building performance ...

- protection of structural elements, both during and after a fire ;
- fire resistance (and smoke resistance) of 'elements of construction', e.g. walls (including properly installed doorsets and sealed penetrating services) ;
- reaction-to-fire of surface materials and finishes ;
- resistance to progressive collapse in fire ;
- resistance to disproportionate damage caused by fire.

More commitment to the issue of protection from fire for People with Activity Limitations is required from building management and local fire authorities; there must be regular communication between the two.

A new level of competence (training and experience) is demanded from all professional disciplines, and any other individuals, involved with the design, construction, control, operation and maintenance of buildings.

C.J. Walsh (visit www.eca.lu to read more about this)

- Signage: informative signs (logos, direction arrows, etc.) should be clear and describe the service which they represent (avoid new designs that create confusion, and the use of letters or initials).

Signage aimed at visually-impaired people should also be installed.

- Lighting should be enough and located in such a way that it is used as a guide in itineraries.
- Filters in well maintained air-conditioning systems should help to avoid allergenes.
- Walls should be free of obstacles so that blind people use them as a guide.
- Unnecessary dangerous elements: certain decorative elements may be dangerous if they are not well designed, installed or indicated:
 - Large mirrors or glass windows that give the space a sense of continuity.
 - Waxed floors which are easy to slip on.
 - Infra-red doors which do not function unless the person is of a certain height.
 - Rugs which are not fixed to the floor.
 - Counters for dealing with the public which have edges jutting out.
 - Reflecting surfaces or floors with drawn floor tiles that can seem a drop.

But in the design of spaces other aspects should be taken into consideration such as allergic people for whom buildings have to be provided with a pollen and bacteria-free air system and also separate the smoking areas.

Leisure activities such as going to the cinema, a museum, restaurant, or visiting shops or superstores, form part of everyday life and, therefore, their accessibility requirements are the same as those of streets or buildings under public ownership.

- Cinemas, theatres and concert venues:
 - The ticket sales window should be at a height that enables everybody to use it.
 - Cinema rooms should include space for wheelchairs, an induction loop system that enables sound to be transmitted in FM and a dialogue system for visually-impaired people.

- All public events should include simultaneous translation into local and other appropriate language and sign language.
- Museums: everybody should be able to follow the same route around the building and so all the exhibition pieces should be in accessible places and the relevant information should be provided in visual, acoustic or tactile format depending on the contents of the exhibition.
- Shops: everybody should be able to look at the goods on display and read the price tag without difficulty. In clothes stores, changing rooms should be totally accessible.
- Restaurants, bars and cafés: food and drinks served, as well as the equipment and service should respect the diversity of the clients (children chairs, menu cards in different languages including Braille, options for vegetarians, coeliacs, religious habits and diverse needs of clients like help to cut the food, etc.
- Sports centres, fairgrounds, stadiums, zoos, etc.: the aspects to be taken into consideration here are, in open spaces, the same as for the public streets and sidewalks, and, with interior facilities, the same as for public buildings.
- Hotels: There should be accessible toilets at the common areas. There should be rooms with accessible doors, adaptable bed height and also shower and washbasin for all those people who need to be helped in the daily activities.

Historical buildings

Some administrations are reluctant to adapt historical buildings, arguing that accessibility improvement can affect historical heritage.

If a castle or a palace remains as it was built, without toilets or electricity and only used for archaeological purposes, just then the previous argument would be acceptable.

But if, on the contrary, the building has a civic use and, therefore, installations such as the above mentioned have already taken place, there is no reason to avoid the improvement of accessibility, providing that the original design is respected and the modifications produced underlined. In this way, everybody would be allowed to enjoy historical heritage.

INTEGRATING HISTORICAL BUILDINGS WITHIN THE BUILT ENVIRONMENT

The cultural treasure that is both represented by and to be found in the many old buildings and building environments that need to be preserved and protected constitute an essential part of our common history. These buildings are often especially inaccessible while at the same time the requirements placed on them in terms of their preservation place obstacles in the way of positive change. Older buildings often contain central functions for the use of the public.

Present-day society places a great deal of practical demands on the old buildings. A part of this is that buildings should be accessible and usable for people with activity limitations. Starting from overall goals for inclusion and normalization examples of making old cultural buildings accessible are presented in order to show that a considerate treatment of the historical value of buildings can be combined with both accessibility and usability for people with activity limitations.

Elena Siré, Architect Royal Institute of Technology - Infrastructure, Built Environment Analysis - Stockholm, Sweden (visit www.eca.lu to read more about this)

HOUSING

The home is a personal space that we share with relatives and friends. It is here that we carry out activities related to our social and individual development and, therefore, it has to be adapted to our lifestyle and any changes which may come about.

Two types of housing can be distinguished:

1. **Individual houses:** the whole lay-out (garden, entrance, rooms, etc.) is the responsibility of those who live in the house.



Picture 025 > Ramp at the entrance of a house

2. **Housing blocks:** here there will be common spaces (entrance, lifts, passages, stairways, garden, etc.) which should be totally accessible, while the lay-out of the homes themselves will depend on the inhabitants.

In both cases, the housing should meet certain minimum requirements: habitability, comfort, safety and the possibility of carrying out activities related to culture and habits, such as eating, resting, studying, working and leisure. But in addition to these minimum requirements, we have to guarantee that every house could be visited by a person with disabilities. So we have to ensure that:

- The access from the street to inside the house should not have a drop or be overcome by mechanical means.
- Doors should be wide enough to allow the way of a wheelchair.
- At least one of the toilets has to allow to manoeuvre with a wheelchair.

Houses that fulfil these requirements are called **visitable**.

In terms of **accessibility**, it should be remembered that although we may have no problems relating to the living environment when we move in, these may appear, either temporarily or permanently, at some point in the future. Therefore, if we wish to build housing that will last an individual's lifetime, regardless of any changes that may occur apart from the visitable houses, we need to consider homes which are convertible and versatile.

Adaptable homes: can be made accessible by simple and low cost interventions.

Also important in this section is the issue of sustainability, that is, ensuring that the well-being of current users does not compromise that of future generations. In this regard, the correct distribution of energy sources leads to better performance for the current user and also provides savings in terms of the energy consumed through general use and maintenance. In addition, for housing to be sustainable it is essential to take into account other aspects such as recycling, the durability of materials, maintenance and environmental conservation.

We believe that the design of all housing should respect the minimum requirements of accessibility, regardless of the building's desired market value, and should not depend on the spending power of the user.

KITCHEN FOR ALL™

The Kitchen for All™ should be flexible and should be able to react to the different and changing demands. If it's possible to adapt the kitchen to changing circumstances of life, it will be a kitchen for a lifetime. The basic requirement is a constructive system which is separated from the additional modules.

Karl Luig (visit www.eca.lu to read more about this)

ACCESSIBILITY HARMONIZATION IN EUROPE

Circumstances have developed in Europe since the mid-1990's & ECA-1996.

All EU Member States and the 2004 Accession Countries must comply with Single Market legislation ... technical barriers to trade are not permitted ... national building requirements must, therefore, be stated in functional terms. Prescriptive requirements must be presented as guidance only.

While Social Policy in each Member State should retain its special national character, there is now a legitimate expectation on the part of People with Activity Limitations (2001 WHO ICF) that deliverables, for example in the form of services and technical guidelines, should become more harmonized throughout Europe. Dramatic

differences in 'quality' from one country to another can no longer be rationalized or explained.

So I would like to propose the idea of an Accessibility EuroCode - a Harmonized European Code of Design & Construction Practice for Accessibility of the Built Environment.

The initial outline contents of the Accessibility EuroCode would cover the following areas:

- Part I - General ;
- Part II - Spatial Planning & Infrastructural Works ;
- Part III - Buildings & the 'Workplace' ;
- Part IV - Protection from Fire in Buildings ;
- Part V - Electronic, Information & Communication Technologies (e-Accessibility) ;
- Part VI - Transport.

The model document type for the Accessibility EuroCode would be a typical Structural EuroCode ... which has been developed within the framework of the EU Construction Products Directive 89/106/EEC.

The 1985 'New Approach' to Technical Harmonization and Standardization requires a specific approach to the drafting of a EuroCode

Accessibility EuroCode Format

A Harmonized EuroCode is intended for the guidance and use of 'competent persons' only. It is a concise document, and is not intended as a design manual.

Regional variations in design and construction practice must be taken into account.

Explanatory text in the Accessibility EuroCode will vary in extent.

A Harmonized EuroCode provides design principles and operational rules for application.

The Principles comprise general statements, requirements and definitions for which no alternative is permitted, unless specifically stated.

The Application Rules are generally recognized rules which follow the statements and satisfy the requirements in the Principles. If, for a particular design, it is desired to use an alternative design rule which differs from the Application Rules given in the document, this may be done provided that the necessary justification is produced to show that the alternative rule complies with the Principles.

Supporting Documents

Harmonized European Product, Performance & Test Standards issued by CEN.

Harmonized European Technical Approvals (ETA's).

In the absence of the above - National Standards & National Agrément Certificates.

Regional Design Manuals in Local Languages.

C. J. Walsh. Architect, Fire Engineer & Technical Controller. Member, CIB Working Commission 14 : Fire. Chief Technical Consultant. Sustainable Design International Ltd. (visit www.eca.lu to read more about this)

PUBLIC INFORMATION SERVICES

Until recently, it was newspapers, television, radio and certain telephone services which were responsible for informing the public about local, national or world events. But nowadays, although these services continue to have a role in providing daily information and in communication, the major advances made in the field of new technology have ushered in what is known as the information society.

Anybody with a computer connected to the Internet can now obtain information about any subject, from any place and in any language (the other communications media even use this resource to obtain news and images).

Furthermore, the development of such technology means that anybody, regardless of their physical, mental or sensory capabilities, can access the same information as the rest of the population: Braille keyboards, browsers for visually-impaired people, voice synthesisers, written information, texts in different languages, option of changing the size of lettering or the colour of the background, etc.

Given the importance of this medium at a social level there are already international guidelines, European directives and national regulations, aimed at making government Web sites accessible:

- The features of the computer or browser being used to access the Web site should not make it difficult to do so.
- Images should be accompanied by a description of them.
- Size of lettering and colour contrasts should be taken into account.
- Animated graphics should be avoided as browsers for visually-impaired people cannot read them.
- It should always be possible to return to the Home page without using the browser buttons.

- Language used should be clear and easy for everybody to understand.
- There should be a detailed index of the different services to be found on the Web site.

Finally, it is important that the whole population has access to these information services, either through the creation of municipal centres which can be visited by users or by providing Internet connections in homes.

WAI, in coordination with organizations around the world, pursues accessibility of the Web through five primary areas of work: technology, guidelines, tools, education and outreach, and research and development. (copied from the WAI website at <http://www.w3c.org/WAI/>)

SUMMARY OF THE CONTRIBUTION ON (NEW) TECHNOLOGIES AND ITS IMPACT ON THE QUALITY OF LIFE OF PERSONS WITH DISABILITIES

The paper is a summary of a report compiled by the author for the Council of Europe, in the framework of a set of Recommendations on the impact of new technologies on the quality of the life of persons with disabilities. A Committee of experts established by the Council of Europe (P-RR-NTH), has prepared the draft Resolution on devising such a policy to the Council of Europe. The Committee of Ministers of the Council of Europe has adopted this Resolution ResAP(2001)3 at its meeting on 24 October 2001.

The Committee of experts collected data from the member states of the Partial Agreement in the Social and Public Health Field of the Council of Europe, from European International Non-Governmental Organisations and from other organisations in various ways over a period stretching from mid 1998 to the beginning of 2001. The information took into account national and international views, policies, programmes, ongoing and planned actions on the impact of new technologies on the quality of the life of persons with disabilities. An external consultant was recruited to analyse the information and to create one overall report. This report and Resolution ResAP(2001)3 can be ordered from the Council of Europe (The Impact of new technologies on the quality of life of persons with disabilities, drawn up by Theo Bougie, and Resolution ResAP(2001)3 approved by the CD-P-RR at its 24th session, The Hague, 26-29 June 2001).

The report provides descriptions of main terms, like Quality of Life.

It also takes into account the different types of disabilities, like impairments of body functions and body structures, restrictions in the execution of activities and problems in participation in the society. This means, for example, that it covers not only physical and

sensorial impairments, but also limitations of learning activities, mental disabilities and restrictions in social participation due to personal or environmental factors.

The report covers new technologies, representing a very wide range of basic, intermediate and applied technology in a vast number of different fields. The term "new technologies" also refers to the increasing speed of development of new products, systems and services based on the application of sometimes highly complex technologies. It includes consumer technology based on design-for-all principles, technology- and services-for-all being part of the technological infrastructure (like public transport, telecommunication, ICT networks, alarm systems), technology used for the physical accessibility of buildings and the built environment and of course assistive technology.

Conditions are formulated to be considered for a successful implementation of new technologies, varying from conditions to be fulfilled for example by the person with disabilities, in the environment (physical accessibility), in the society but also in the framework of legislation, service delivery conditions, design, standardisation and market development.

The conclusions show that new technologies can increase the quality of life for persons with disabilities, even more than traditional technology does. However, a coherent set of actions is needed in order to avoid new technologies simply creating new barriers for groups who are at risk on account of particular disabilities, particular activities and participation in society. In order to attain a society for all, this wide range of measures has to be considered seriously in order to avoid severe isolation or illiteracy.

Author: Theo Bougie MSc (visit www.eca.lu to read more about this)

CHAPTER 4

RECOMMENDATIONS FOR MANAGING THE ACCESSIBILITY
THE EXAMPLE OF MUNICIPALITIES

THE CITY FOR ALL PLAN

In the previous chapter we described a series of recommendations for adapting environments in ways that take into account the diversity of the population. However, for such adaptations to become a reality it is essential to have a method of intervention that brings together the different parties involved in the process (for example, politicians, experts, representatives of associations).

The City for All Plan can be a useful tool in specifying areas of action and in defining a system of management, as well as for co-ordinating, analysing and evaluating the opinions of all those involved: politicians, experts, citizens and employees. In what follows, we describe a potential plan consisting of seven stages which, except for the diagnosis, unfold more or less in parallel.

- Diagnosis
- Political planning
- Involvement of citizens
- Technical planning
- Contribution of citizens
- Management
- Information to citizens

Diagnosis

Prior to designing a method of intervention it is necessary to understand the current state of the environment by collecting and analysing existing data on:

1. **People:**
 - Age pyramid
 - Growth trends
 - Territorial distribution
 - Census of people with disabilities and/or those at risk of social exclusion

- Associations
 - Links between the local council and associations
 - Needs of the population
2. **Environments:**
- Urban space
 - Buildings
 - Transport
 - Municipal services
3. **Management:**
- Political action
 - Administrative structures
 - Participatory networks
 - Training of experts in Design for All

Analysis of the data collected will provide detailed information about the actual state of the environment, and this document will be a valuable basis on which to plan intervention.

If, like in Esch-sur-Alzette, the city carries out a diagnosis, the main accessibility problems appear in their real dimension.

<http://www.esch.lu>

Political planning

Having drawn up the document on the current state of the environment the next step concerns political leadership and the planning of future interventions.

- a. **Political leadership:** nominating members of local government who will accept responsibility for creating the City for All, as well as those who will take on specific aspects of management, planning and dissemination of information.

In addition, a list should be drawn up of those local council areas that will play an important role (for example, social welfare, town planning, sports, maintenance) and, in order to ensure smooth running, an internal coordinating committee should be set up.

- b. **General priorities:** in order to plan the development of the intervention the information collected during the diagnostic stage should be collated with the political programme and any interventions being planned by non-municipal promoters (gas, water, fibre optic companies, etc.).

When setting priorities it should be remembered that it is not only the public streets and sidewalks which should be accessible, but also information and services (for example, sport, Web sites, parking facilities).

EL PLAN CIUDAD PARA TODOS DE BARCELONA

Occasionally, we forget that the problems for using spaces, services or products of the environment of daily life are not exclusive to people with disabilities, but contrary to what it seems, we concern ourselves with everyone at some point or another in life.

When we set out from Barcelona City Council to make a reality the City for All, we thought citizen participation was of paramount importance, since each person is unique from another, and therefore, having different needs.

The Barcelona City Hall backed for a good technical team, formed of specialists in various fields, to shape the foundations of the Accessibility Plan and watch over the correct development, the continuance of the proposed stages and the final valuation of the interventions. This group was widened to form a Working group in which, apart from technicians, several different citizen groups were represented (disability associations, neighbours, business people, etc.).

Our aim was that the citizens as well as visitors to Barcelona could enjoy a good quality of life, using it in an autonomous way the services and activities that the city offers and participating in the development of it.

Presently, thanks to the positive co-ordination of the Working Group and the various social agents that intervene the development of the Plan, the accessibility in the equipment and services of the city have tripled.

The transformation that has been produced in the city since the Plan confirms, yet again, that accessibility benefits us all...

Francesc Narvàez (visit www.eca.lu to read more about this)

Involvement of citizens

Once local government has defined its priorities it is essential that council representatives meet with residents in order to inform them about:

- The political will to create a City for All
- Who will take the political leadership
- Method for developing the plan
- General priorities being put forward
- System by which residents will become involved in the process

However, in addition to providing information this first contact with residents should aim to hear their opinions about the plan. Therefore, those invited to the meeting should include not only those people who appear to be directly affected by conditions of accessibility, but also those interest groups and associations which would appear not to be affected (resident's associations, shop and bar owners, etc.) because, as users, they come into daily contact with the environment in question and will have specific needs (for example, loading and unloading of goods, setting up terraces in front of bars and cafés, children's areas).

Technical planning

After the meeting with residents has been held their opinions need to be integrated into the general priorities. Once this is done, work can begin on planning the interventions and, subsequently, deciding the practical procedures for carrying them out.

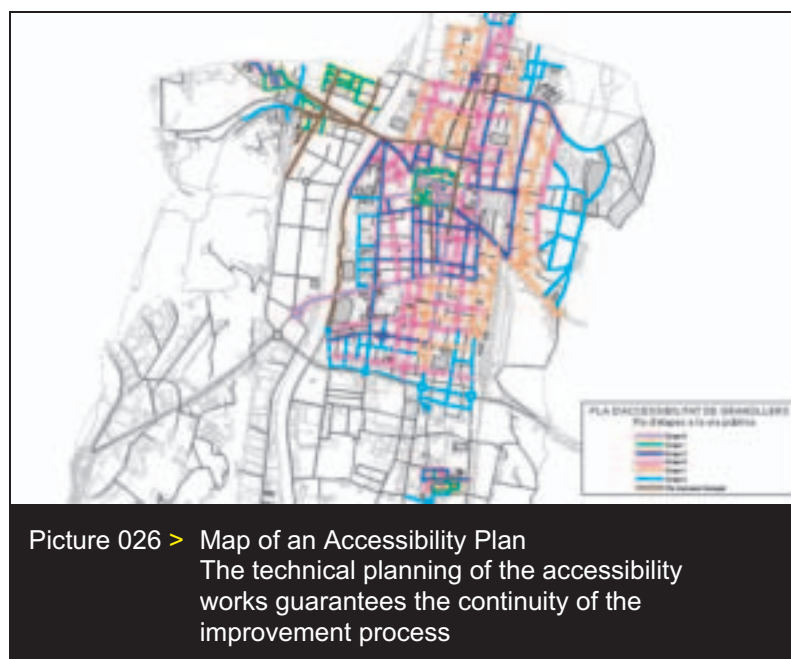

The potential procedures are as follows:

- Integration within the existing urban maintenance plan.
- Integration within new projects and services to be carried out during the current term of office.

In Helsinki, the involvement of users' organisations have dramatically improved the accessibility Plan of the city.

The technical planning of the accessibility works guarantees the continuity of the improvement process:

- Developing an analysis of accessibility and sustainability of services or including Design for All criteria in internal quality systems (improving the quality of services in terms of usability, participation and overall quality).
- Integration within projects of other social agencies, whether private or other governmental bodies.
- Citizen awareness and participation campaigns (some problems of accessibility are created by people themselves, for example, badly-parked cars or other obstacles in the public highway).
- Normative development, in other words, the development of internal norms and regulations that modify or improve the present state of affairs.

- Creation of a specific budgetary item for those aspects of accessibility that cannot be addressed by the above procedures.

ACCESS AUDITS – A TOOL FOR THE PLANNED IMPROVEMENT OF ACCESSIBILITY OF THE BUILT ENVIRONMENT

An access audit is a means of evaluating a building and services for their accessibility to disabled people. The access audit consists as a minimum of a site visit and a report with recommendations for action.

What are access audits for?

Access audits provide the basis for an access improvement plan or strategy.

They may be commissioned because they:

- are required by grant makers or other project funders
- enable service providers to respond to legal obligations
- are recognised good practice in updating buildings and services

What will an access audit cover?

Access audits do not look at the building in isolation. They take a broad look at how the building is used and review the accessibility of the services on offer. Issues likely to be covered include:

- getting to the building
- public spaces
- staff areas
- services and facilities
- policies, practices and procedures
- customer service
- information and publicity
- interpretation and alternative means of access

Sarah Langton-Lockton, 8 July 2003 (visit www.eca.lu to read more about this)

Contribution of citizens

Once it has been established which interventions are to be carried out, another residents meeting should be called in order to inform them of the specific objectives and, once again, gather their opinions.

The final outcome of the technical planning, approved by the local council, will be disseminated via the media which the council normally uses.



Management

Each local council should draw up a City for All Plan in accordance with its customs, scope of responsibilities and possibilities. Thus, our aim in this section is to illustrate a possible model - by no means the only one - based on the creation of a working party which we shall call the City for All Plan Team. This team should be led politically by a senior member of local government and should include representatives from each of the areas involved in the plan. The Council should also appoint a Team Co-ordinator.

In the city of Blanes (Spain) a local decree was put into force to guarantee that the water, electricity and gas providers will build accessible sidewalks when closing their maintenance works.

The **team's functions** would be as follows:

- Table proposals for large-scale interventions so that they receive Council approval.

- Approve minor work and modifications.
- Monitor the development of the work.
- Prepare the technical planning for the next term of office.
- Act as a negotiating body with respect to sources of external funding.
- Detect any irregularities.
- Take any necessary internal disciplinary or, in the case of external agencies, legal measures.
- Meet with residents.
- Prepare the material to be disseminated.

Experience has shown that, provided the co-ordinator is closely involved in the activity and the control mechanisms are correct, then a bimonthly group meeting is sufficient to ensure that the plan develops properly.

The **role of the co-ordinator** is to ensure that:

- The initial diagnosis is documented in a format that guarantees the constant updating of data.
- Control mechanisms are developed and maintained.
- The experts with responsibility for projects within the plan have the necessary training and supervision.
- The philosophy behind the plan is communicated internally to the local Council and social agencies.
- The necessary modifications are carried out and documented.
- Periodic management reports are drawn up, along with a report that summarises the planning.
- All opportunities for external funding are taken advantage of.
- The technical planning for the next term of office is drawn up.

In all European cities where a co-ordination has been appointed, the accessibility commitment of the city has been really increased.

In summary, the work of the co-ordinator is fundamental for the plan, as good management will maximise the interventions with a minimum of necessary resources.

Information to citizens

At the start of the planning process it would be wise to hold more regular meetings in order to ensure good communication between residents and council representatives, especially if this has not previously been usual practice. However, once mechanisms of participation are established, it will be sufficient to meet with residents on those occasions when a meeting is called to present monthly reports; this will be the opportunity for residents to give their opinions on how the plan is developing and offer suggestions for improving it.

This phase would also include the dissemination of information in the media describing how the project is developing, the beginning or completion of a key part of it, and end of year results.

All the citizens value positively the local government concern for the accessibility improvements.

ACCESSIBLE BUILDINGS – FROM PIPE-DREAM TO REALITY

During the last 20 to 30 years, many hundreds of laws, standards and guidelines for accessible buildings for disabled people have been published. However, travelling through Europe in my wheel chair, I note the existence of countless obstacles everywhere and, which is worse, new obstacles are being erected all over.

Despite the fact that, for 30 years, there has been a demand for accessible buildings for disabled people in many European countries, such buildings are far from being the norm. To put the theory finally into practise in the daily and continuing routine of building, four complementary instruments are required in every country. In particular, if there is no network of local experts on hand to check projects and provide advice, the idea of accessible building being incorporated in each and every building project will never become reality.

1. **Practical laws and guidelines**
Texts such as laws, standards and guidelines must include specific goals and requirements. Having these specifications on paper is an essential and fundamental instrument. But the mere existence of information and legal regulations is obviously not sufficient.
2. **Local lobbying and control**
Laws, regulations and guidelines are only respected and implemented where local lobbying and control exist for every single building project.

3. Network of local experts

For every building which is constructed to be accessible for everyone, specific questions arise which cannot be answered on paper. Mainstream planners and architects do not have the specialised knowledge or the necessary experience. Practically every building would require expert advice. Hence the need for a network of regional advisers, both for conceptual planning and for the realisation.

4. National centre for accessible building

Each country should have a national centre of expertise for the exchange of experiences and the co-ordination of local promoters and experts. The centre should have complete documentation covering the country in question. It would be responsible for identifying and collecting basic resources and know-how.

In Switzerland, for example, these four complementary instruments have been refined over the last 20 years. They are now beginning to have a positive effect. As of 2003 the situation of the instruments is as follows:

- population: 7.5 million
- relevant building projects: about 15,000 per year
- regional network of experts and lobbyists: 22, in other words, 1 expert for every 700 building projects
- national advice centres: 2 with about 7 experts each
- laws/guidelines: 1 national non-discrimination act, 26 regional building laws including regulations for accessible building, 1 national building standard, 20 additional guidelines and technical brochures (all in German and French)

Joe A. Manser, architect, Director Swiss Centre of Accessible Building for Disabled People 19.6.2003 (visit www.eca.lu to read more about this)

CHAPTER 5

WIDENING EUROPE WITHOUT REPEATING MISTAKES

WIDENING EUROPE WITHOUT REPEATING MISTAKES

Historically the concern for the accessibility has been closely related to the level of democracy and the economical growth. Therefore, the cities' involvement in the accessibility improvement in Europe depends also on these factors.

It is important not to repeat the mistakes made in the past but be inspired by the successful recent stories.

Important hints for cities starting their way to be a City for All:

- Accessibility is for all the citizens and not only for wheelchair users.
- There is the need for a clear and understandable legal framework in accessibility. The 2003 ECA can be the basis for this like it has been in the past and still is different in European countries.
- Citizens have to participate in the decision process and be informed about the plans and the results.
- Before inventing something, do use the international networks to find out how a similar situation has been solved in other cities.
- Investigate the possibilities of external finance support throughout programs from another administration or the European Commission.
- Any of the municipal employees with a high profile could be taught about accessibility in order to become the City for All Plan co-ordinator. In order to do so, we recommend the cooperation with cities that have already a City for All Plan.
- Do involve as much social actors as possible in the process.

NATIONAL STANDARDS

Visit www.eca.lu to get an overview of National Standards presented in a comparable format

BRUSSELS, 30.10.2003 COM(2003) 650 FINAL**Equal opportunities for people with disabilities: A European Action Plan****1. EXECUTIVE SUMMARY**

A crucial issue for the success of the European Year of People with Disabilities 2003 is whether it will produce sustainable results beyond 2003. The European Commission, together with all the partners involved in the Year, wants to build on its momentum and achievements while confronting new and acute challenges. This Communication aims to achieve a sustainable and operational approach to disability issues in the enlarged Europe. It will provide a reference point and framework for reinforcement of the disability dimension in all relevant EU policies, while supporting or stimulating policies at national level.

The present Communication accordingly outlines forward-looking EU initiatives aimed at the further inclusion of people with disabilities in an enlarged EU economy and society as a whole. Three operational objectives are central to the proposed approach: achieving full application of the Equal treatment in Employment and Occupation Directive (2000/78/EC), reinforcing mainstreaming of disability issues in relevant Community policies, and improving accessibility for all.

In particular, this Communication introduces a rolling multi-annual Action Plan with the time horizon of 2010. The goal of the Action Plan is to mainstream disability issues into relevant Community policies and develop concrete actions in crucial areas to enhance the integration of people with disabilities. As an instrument to support mainstreaming of disability issues in key EU policies, the Commission will publish a biennial report on the overall situation of people with disabilities in the enlarged EU, taking on board new developments in the Member States. At the same time, the Commission proposes to reinforce the involvement of stakeholders and key players in the policy dialogue in order to bring about far reaching and lasting changes within the economy and society as a whole.

As employment remains the most critical factor for social inclusion, the first phase of implementation of the EU Disability Action Plan - which is due to be developed in 2004 and 2005 - will focus on creating the conditions necessary to promote the employment of people with disabilities, while making the mainstream labour market more accessible to them across the enlarged Union. Accordingly, the first phase of this Action Plan will concentrate on four concrete employment-related priority actions:

- access to, and retention in, employment including the fight against discrimination;
- lifelong learning to support and increase employability, adaptability, personal development and active citizenship;

- new technologies to empower people with disabilities and therefore facilitate access to employment;
- accessibility to the public built environment to improve participation in the work place and integration into the economy and society.

The Commission biennial Report on the overall situation of people with disabilities in the enlarged Europe will be used as a basis for identifying new priorities to be addressed in the following phases of the Action Plan in the light of the impact of EU policies on the situation of people with disabilities.

COMMUNICATION FROM THE COMMISSION TO THE COUNCIL, THE EUROPEAN PARLIAMENT, THE EUROPEAN ECONOMIC AND SOCIAL COMMITTEE AND THE COMMITTEE OF THE REGIONS (visit www.eca.lu to read more about this)

ANNEX

ACCESSIBILITY STANDARDS

ACCESSIBILITY STANDARDS

Even though this was not the initial intention, the authors of this document decided to completely include the chapter about accessibility standards as it was already contained in the 1996 version of the European Concept for Accessibility.

WHAT CRITERIA STAND FOR

Everyone must be able to use the built environment in an independent and equal way. This is the objective of universal design and the European concept for accessibility. It should, of course, be possible to determine objectively whether a constructed facility or the design for one meets this objective. This is the purpose of the criteria in this chapter.

Minimum level

The criteria represent the spatial and technical needs of people as they undertake the activities which are relevant for the use of built facilities. As with the principle of universal design, the extremes in human build and possibilities implicitly represent the needs of every separate individual within these limits.

The criteria provide a minimum level which is based on various studies, empirical material and data based on the expertise of the experts in the steering group involved in the concept.

Many countries apply their own criteria, set down in manuals, regulations or standards. The countries which apply more far-reaching criteria should regard their own criteria as the yardstick. In contrast, the countries which adopt a lower level should focus on the criteria of this concept.

As an illustration, the dimensions regarded as desirable by the Nordic countries (Denmark, Finland, Iceland, Norway and Sweden) are given between brackets.

Not rigid

For that matter, the criteria in the concept are not laid down rigidly. The criteria will be up-dated as new research or social or technological developments suggest. In this way, the ultimate goal will be approached: that literally everybody will be able to make use of the built environment in an independent and equal way.

In the meantime, every country and every constructor, of course, is encouraged to strive towards a performance which exceeds the given criteria and the requirements derived from them.

1. HORIZONTAL MOVEMENT

People have to be able to move around freely and without obstruction. With regard to walkways, attention must be given to width, turning space, headroom, level surfaces and means of orientation and warning.

Widths

The minimum width for any walkway is determined by the intensity of its use. The greater the use, the more often will people meet and have to pass one another.

A = when people never have to pass one another

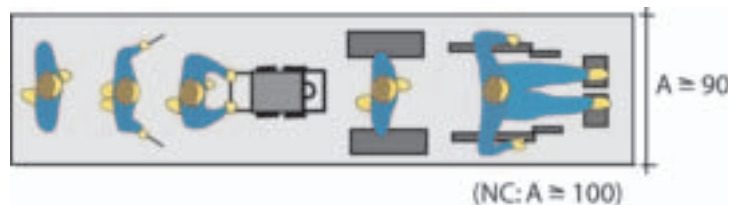

B = when people pass each other occasionally

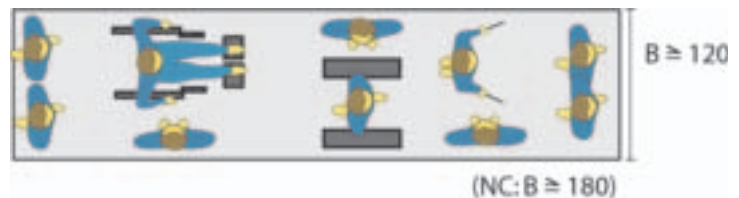

C = when people regularly have to pass one another

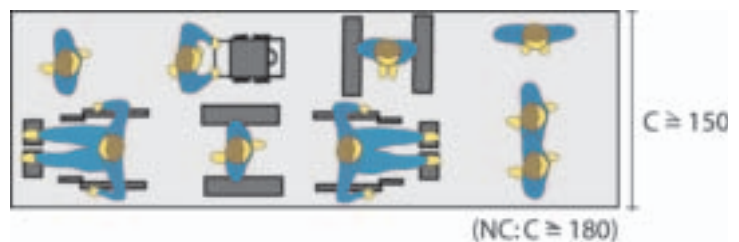

D = when people are continually meeting and passing each other

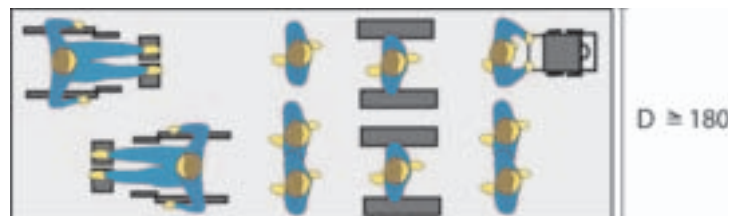

E = when there is an occasional narrowing in the walkway

F = when a 90-degree turn has to be made into a porch or a door opening

G = the speed at which people are able to move (this criterion is important, for instance, when determining how long automatic doors remain open and the rate at which pedestrian crossing lights change)

(NC: criterion of the Nordic Countries)

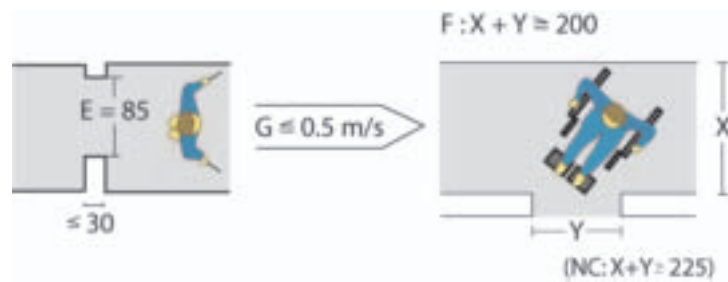

Turning space

In walkways with a dead end, when faced with closed doors and using equipment, space to turn is needed.

H = space needed for a 90-degree turn

I = space needed for a 180-degree turn

J = practical guideline for 90-degree, 180-degree (and 360-degree) turns

K = practical guideline for easy 180-degree (and 360-degree) turns in an electric or other wheelchair

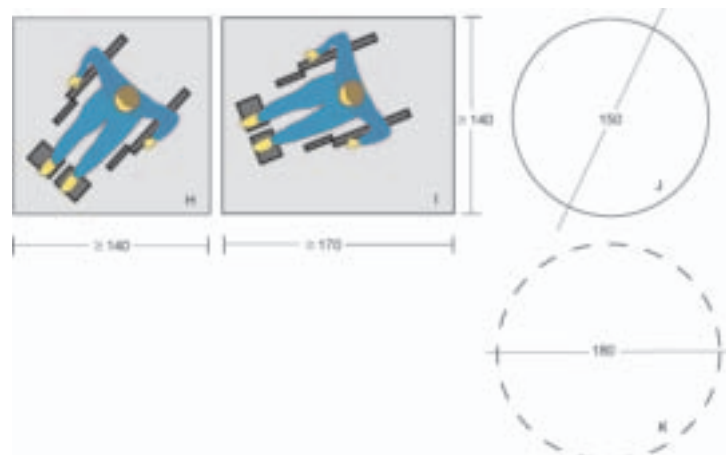

Headroom

Everyone should be able to use a walkway without continually having to stoop.

Level surfaces

The surface of walkways must be free from any irregularities which create obstacles or may be dangerous.

L = minimum headroom

M = minimum headroom for doorways

N = diameter of openings in the surface of walkways, such as floor grids or gratings

P = smoothness of walking surface

Q = acceptable difference in floor levels without the need for special provisions

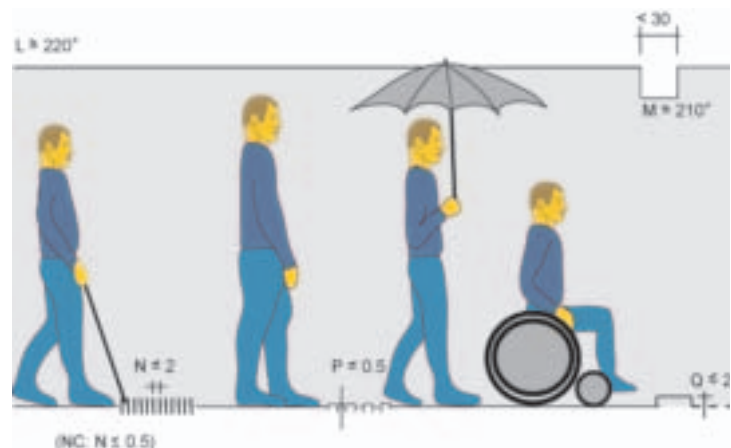

Means of orientation and warning

When moving around people must be able to find their bearings and be made aware of any obstacles. Especially blind and partially sighted people are continually dependent upon detectable markings clearly defining the walkway and giving early warning of obstacles.

R = detectable markings defining a walkway

S = area to be marked in order to give sufficient warning for objects in the walkway such as street furniture or a staircase

(NC: criterion of the Nordic Countries)

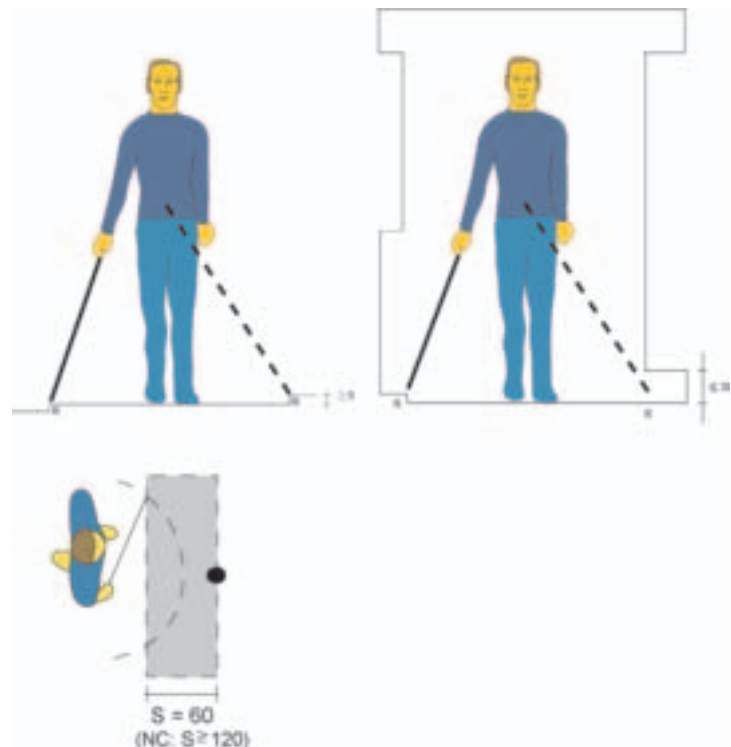

2. VERTICAL MOVEMENT

There is always an element of difficulty for people when bridging varying heights. But everyone using a walkway should be able to overcome the differences with as little effort as possible.

A lift makes it possible for everyone to bridge the difference with a minimum of effort. Not everyone can use the stairs, nor is a sloping ramp suitable for everyone. This means, therefore:

- differences in height should be avoided or reduced to a minimum
- it is generally considered that for everyone to be able to overcome a difference of more than 20 mm in floor level, either a lift or a combination of stairs and a ramp are needed
- a ramp with a gradient of less than 1:20 can be used by everyone, thus a complementary staircase is unnecessary

(NC: a complementary staircase is always necessary)

Ramps

The gradient of a ramp should be kept to a minimum.

The maximum angle depends upon the height to be bridged.

A = maximum gradient of a ramp up to 150/175 mm

B = maximum gradient of a ramp up to 500 mm

(NC: criterion of the Nordic Countries)

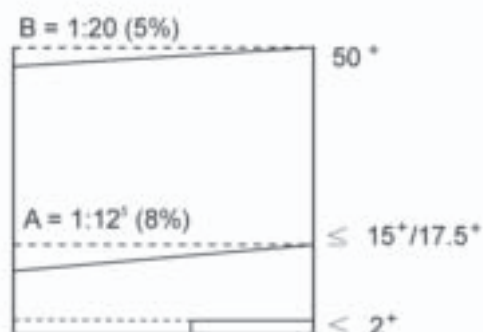

Lifts

The floor area and the hoisting power of a lift must be at least adequate to take a person in a wheelchair and whoever accompanies him.

C = minimum floor area for a lift (platform)

D = minimum floor area for a staircase lift when the companion uses the stairs

E = required hoisting power of a lift

F = required hoisting power of a staircase lift

G = space needed for turning in front of the lift door

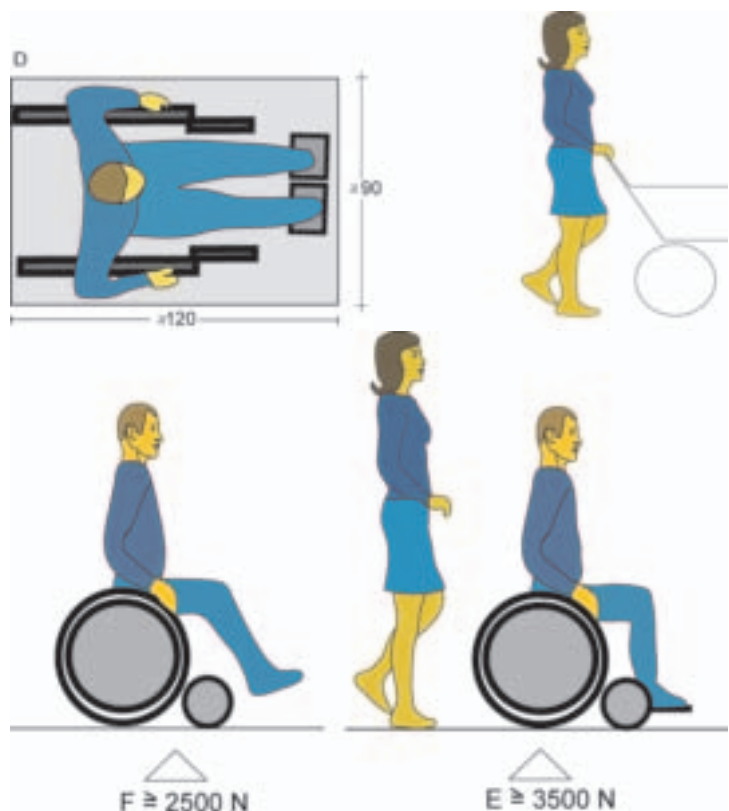
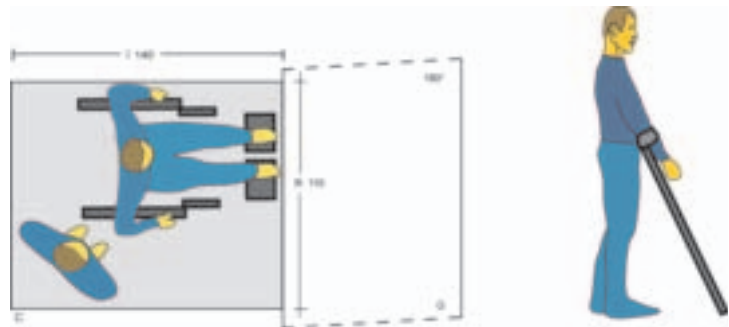

Steps and stairways

The ease and safety with which people use stairs depends upon the height and depth of the tread, and their ratio to one another. Support and assistance when ascending or descending is equally important.

H = height of a tread

I = the depth of a tread according to the given formula

J = safe nosing

K = height of a handrail giving sufficient support

L = length of a handrail at the start and end of a stairway that provides sufficient support and assistance

(NC: criterion of the Nordic Countries)

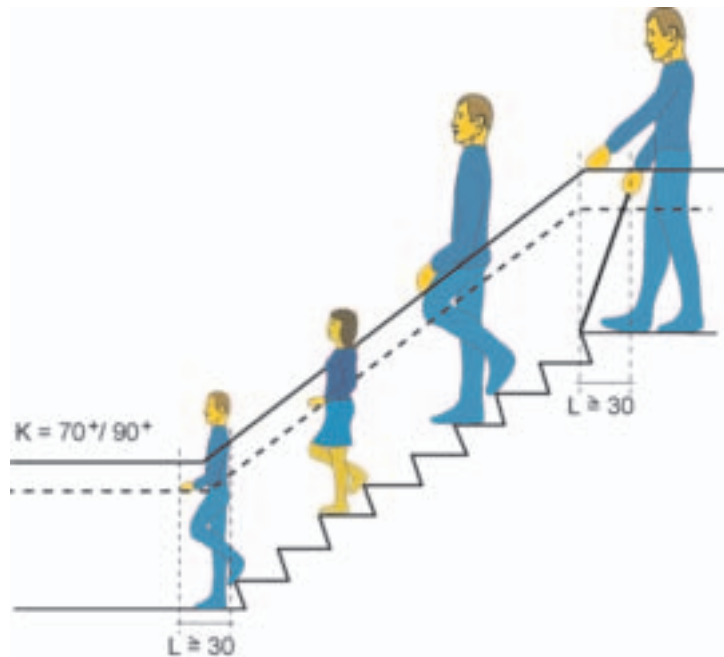
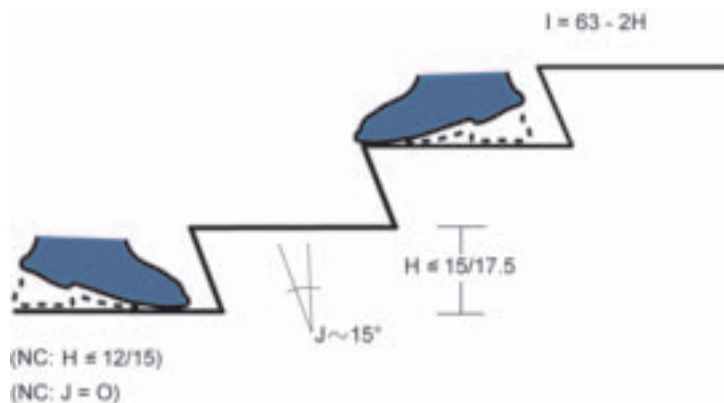

3. VARIOUS ACTIVITIES

Besides moving around in a building, people are constantly using the facilities provided. This chapter presents criteria for various other activities: use of doors, operating, reaching, holding, sitting and perceiving information. The different physical abilities and restrictions of people should be taken into account as much as possible to enable everyone to perform these activities independently.

Use of doors

Firstly, a doorway has to be wide enough to go through. If it is not, some people are quite literally locked out.

To ensure 'independent' use of a door there has to be enough room to operate it. The space required is determined by the opening circle of the door and how the door is approached. For instance, someone in a wheelchair needs enough space to operate the door handle and yet manoeuvre outside the opening arc of the door. Opening a door must cost as little energy as possible.

A = opening without obstacles

B = maximum opening resistance

C = a door approached from the side

D = a door approached from the front

X = space needed on the lock side of the door

Y = space needed outside the opening circle of the door

E = space needed for using a car door

(NC: criterion of the Nordic Countries)

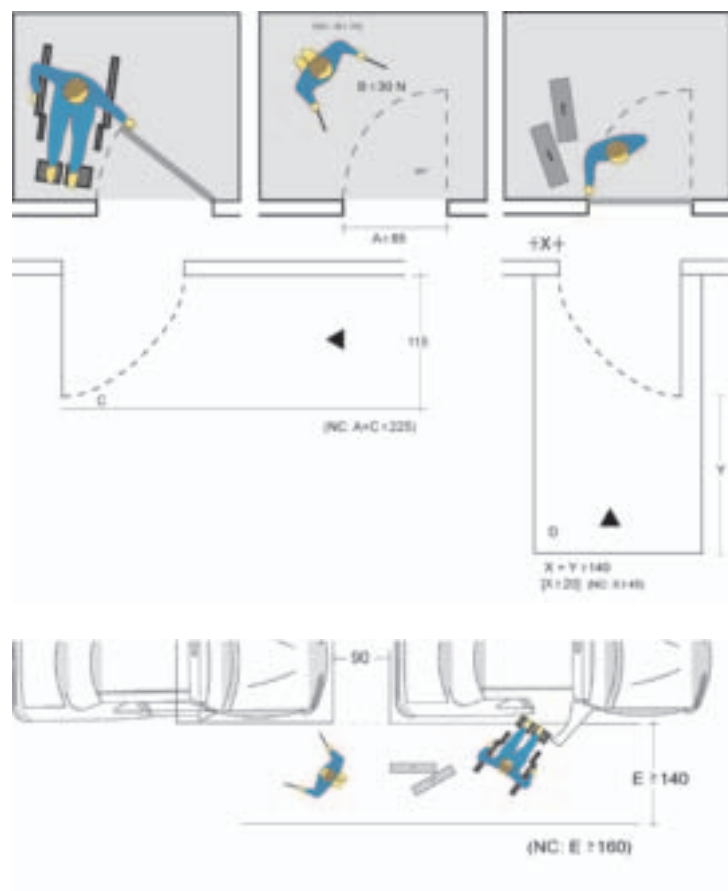

Operating, reaching and holding

Strictly speaking, the ideal height for all facilities used by hand is decided by the needs of the individual. But where these facilities are used collectively - by those who are tall and those who are short, by children and by people with restricted arm movements - a suitable height range has been determined.

A = suitable height for door handles, light switches, public telephones and the service panel in a lift

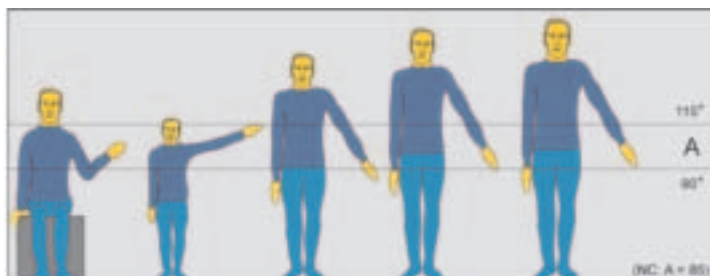

B = suitable height for coat hooks, book shelves, etc.



C = the space needed to operate a switch that is fixed in a corner

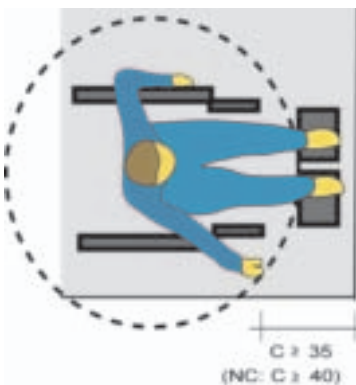

Handrails have to be fixed at a height that make them suitable for as many people as possible to use. They also need to feel firm in the hand.

D = suitable height for handrails

(NC: criterion of the Nordic Countries)

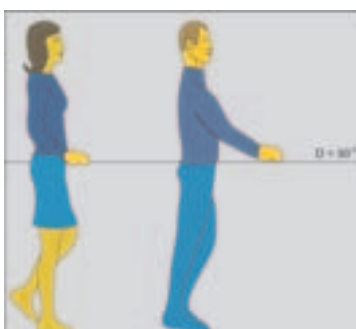

E = appropriate diameter for a handrail

F = space needed between the handrail and the surrounding elements such as the wall

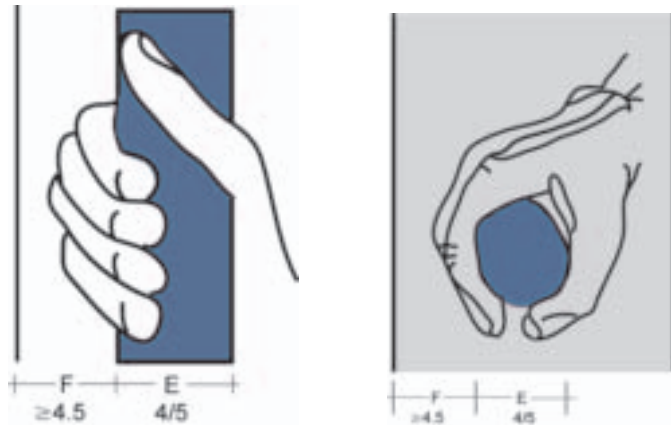

Sitting

The ideal height of a chair or a working surface depends on the individual. But when working surfaces (desks, tables and counters) and chairs (in restaurants, theatres, waiting rooms and toilets) are used collectively, the basic measurements have to be based on a certain average.

A = suitable height for sitting

B = suitable height for a working surface

C = free space under a working surface



In a number of situations, people in wheelchairs have to transfer from their wheelchair to another kind of seat. This happens particularly in sanitary areas such as the toilet, the shower and changing rooms, as well as inside the home.

Every person in a wheelchair has his own particular method of transferring to another seat. In general there are three types of transfer techniques (without assistance), each demanding its own space.

D = the three main types of transfer techniques

E = space needed for the three techniques in a toilet

F = space needed to turn in a toilet, changing, shower cubicle

X = line to reflect the transfer space needed if both right and left-sided transfers and/or assistance must be possible

(NC: in public toilets left, and right-sided transfers and transfers with assistance must be possible)

(NC: criterion of the Nordic Countries)

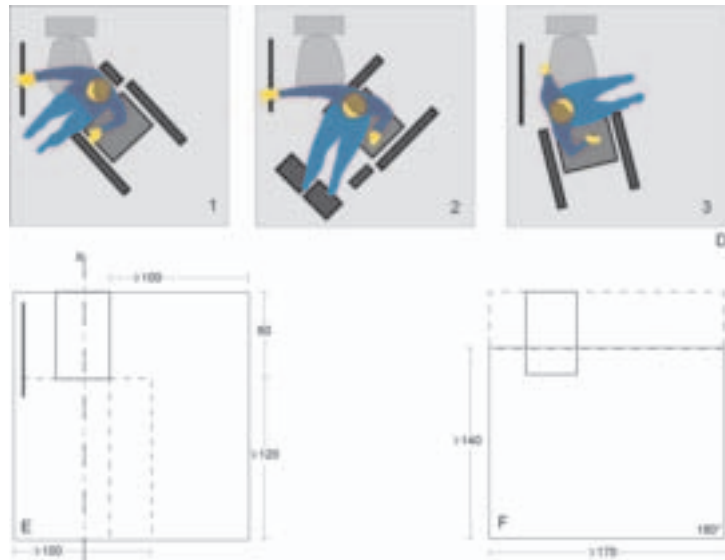

Perceiving information

People must have the information which is important for their use of a built facility. This calls for attention to be paid to the way in which visual, audible and tactile information is presented.

The height at which the information is placed requires thought as well as ensuring that there is a clear line of vision for the tall and the short and everyone in between.

G = clear line of vision when standing

H = the average height for information at 'reading distance'

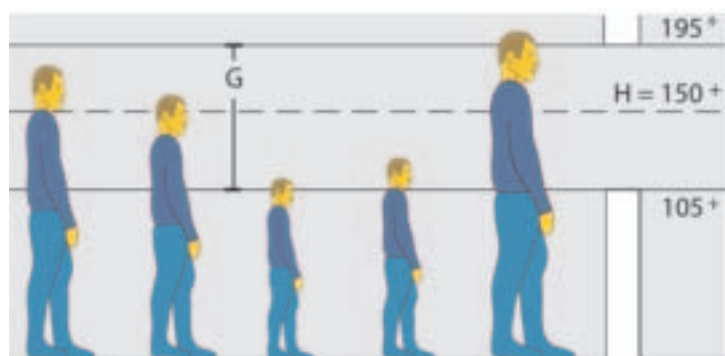

I = clear line of vision when sitting

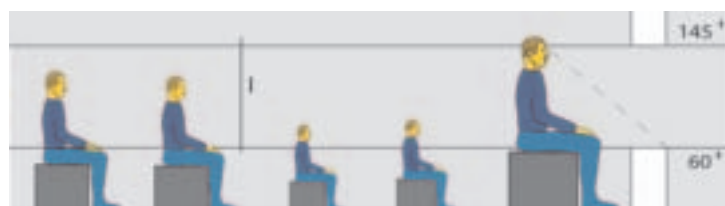

The relevant information for quick and easy use of a building must be clearly visible and immediately understandable.

The following are essential for 'visual' information:

J = sufficient contrast between the information and the background (text, switches and door handles)



K = readily understood symbols combined with classic colour use:

- blue for information
- green for safety
- yellow for risky
- red for danger/emergency



L = sufficiently large symbols, depending on the distance at which they have to be read

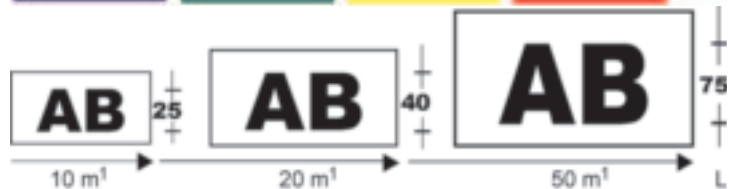

M

N

P

By definition blind people are unable to make use of visual information and it is difficult for partially sighted people to do so. It is therefore essential that important information should be made detectable. This is possible when a relief is used on a switch for instance (M) or the information is given audibly over an intercom.

For people with a hearing impairment it is essential that information is amplified (N) and where possible, made 'visible' for deaf people (P).



binsfeld

**Un voyage
de mille lieues
commence toujours par
un premier pas.**

Lao-Tseu



SOCIÉTÉ NATIONALE
DES CHEMINS DE FER LUXEMBOURGEOIS